

DLR/NASA Design Challenge 2018

The 'eRay' Aircraft Concept

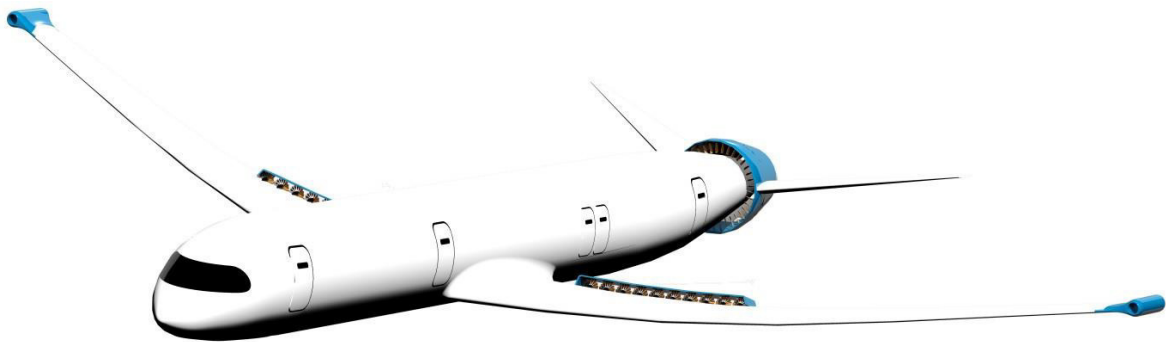

Team

Alexander Frühbeis, Isa Held, Patrick Sieb and Artur Usbek

Academic Support and Advisors

Institute of Aircraft Design, TU Munich

Univ.-Prof. Dr.-Ing. Mirko Hornung

M.Sc. Lysandros Anastasopoulos

Submitted on July 1st, 2018



Technische Universität München

Technische Universität München · Lehrstuhl für Luftfahrtsysteme
Boltzmannstraße 15 · 85748 Garching · Germany
Lehrstuhl für Luftfahrtsysteme
Institut für Luft- und Raumfahrt
Boltzmannstraße 15
85748 Garching b. München



Fakultät für Maschinenwesen
Institut für Luft- & Raumfahrt
Lehrstuhl für Luftfahrtsysteme

Prof. Dr.-Ing.
Mirko Hornung

Boltzmannstraße 15
85748 Garching bei München

Tel +49.89.289.15981
Fax +49.89.289.15982

sekretariat@lfs.mw.tum.de
www.lfs.mw.tum.de

Garching, 19. Juni 2018

Bestätigungsschreiben

Sehr geehrte Damen und Herren,

mit diesem Schreiben wird bescheinigt, dass der Beitrag der Studierenden zum studentischen Wettbewerb *DLR-NASA-Challenge 2018* am Lehrstuhl für Luftfahrtsysteme geprüft und genehmigt wurde. Die Einreichung der Berichte wird damit befürwortet.

Bei weiteren Fragen können Sie sich gerne an mich oder den betreuenden Mitarbeiter Herrn Lysandros Anastasopoulos (lysandros.anastasopoulos@tum.de) wenden.

Mit freundlichen Grüßen

Univ. Prof. Dr.-Ing. Mirko Hornung
Ordinarius des Lehrstuhls für Luftfahrtsysteme



Technische Universität München

Technische Universität München · Lehrstuhl für Luftfahrtsysteme
Boltzmannstraße 15 · 85748 Garching · Germany

Lehrstuhl für Luftfahrtsysteme
Institut für Luft- und Raumfahrt
Boltzmannstraße 15
85748 Garching



Fakultät für Maschinenwesen
Institut für Luft- & Raumfahrt
Lehrstuhl für Luftfahrtsysteme

Prof. Dr.-Ing.
Mirko Hornung

Boltzmannstraße 15
85748 Garching
Germany

Tel +49.89.289.15981
Fax +49.89.289.15982

sekretariat@ils.mw.tum.de
www.ils.mw.tum.de

Garching, 29.06.2018

Bestätigungsschreiben

Sehr geehrte Damen und Herren,

hiermit bestätige ich, dass die Mitglieder der studentischen
Arbeitsgruppe (LLS-Team 1):

- Alexander Frühbeis
- Isa Held
- Patrick Sieb
- Artur Usbek

die Arbeit zum Wettbewerb DLR-NASA-Challenge 2018 eigenständig
angefertigt haben.

Bei weiteren Fragen können Sie sich gerne an mich oder den
betreuenden Mitarbeiter Herrn Lysandros Anastasopoulos (Email:
lysandros.anastasopoulos@tum.de) wenden.

Mit freundlichen Grüßen

Christian Rößler

Akad. Rat des Lehrstuhls für Luftfahrtsysteme

Team members



Alexander Frühbeis, B.Sc.

Team Lead

Master Student Aerospace Engineering
2nd semester

Aerodynamics, Propulsion Concept,
Parametric Model, Control & Stability



Isa Held, B.Sc.

Master Student Mechanical Engineering
1st semester

Concept of Operations, Electrical
Components, Layout, Big Picture



Patrick Sieb, B.Sc.

Master Student Aerospace Engineering
2nd semester

Market Analysis, Turbine Technology,
Battery System, Cabin Layout, Costs



Artur Usbek, B.Sc.

Master Student Aerospace Engineering
2nd semester

Aerodynamics, Parametric Model, CAD,
Drafts

Contents

1	Introduction and Market Analysis - Roadmap 2045	1
2	Methodology	2
2.1	Parametric Model	2
2.1.1	Energy Consumption	2
3	Concept Selection	3
3.1	Basic Design Consideration	4
3.2	Refined Layout	5
4	Our Concept: Technical Specification	6
4.1	Structure and Masses	7
4.2	Aerodynamics	8
4.2.1	Laminar Flow Control	9
4.3	Propulsion	10
4.3.1	Propulsive Efficiency	11
4.3.2	Optimizing Turbine Technology	12
4.3.3	Battery System	14
4.3.4	Electrical Components	15
4.4	Control and Stability	17
4.5	Energy Consumption	18
4.6	Cabin Concept	19
4.7	Summary Baseline and Best Case Concept	20
4.8	Prospect: Aiming for 80% Energy Reduction	21
5	Operation Concept	21
6	Feasibility and Cost Estimation	23
6.1	Key Technologies	23
6.2	Manufacturing Costs	23
6.3	Operating Costs	24
7	Conclusion	24
7.1	Results	24
A	Appendix	32

Abstract

The eRay concept meets the future demand for ultra efficient aircraft. A qualitative study examines various basic concepts and defines the framework of a turbo-electric distributed propulsion (TEDP) aircraft with Laminar-Flow Control for improved aerodynamics and CRP structures for decreased mass. The TEDP layout is further specified to consist of electric fans distributed along the wing and one around the aft fuselage. The electric engines are powered by a turbine and a generator placed on each wing tip and a battery for buffering. A parametric model links aerodynamics, mass estimations and propulsion creating a digital twin of the reference airplane and the investigated concept. Iterating over several input parameters led to a conservative and a more optimistic concept to consider uncertainties regarding technical and social developments until 2045. The technical concepts differ through qualitative input parameters like battery densities and through bolder design features like the lack of a vertical stabilizer. The optimistic version leads to the promoted concept "eRay", showing mass reduction of 30%, (L/D) improvement of 24% and propulsive efficiency improvements of 48% compared to 2005's state-of-the art reference aircraft leading to an overall improvement in energy consumption of 64% compared to the Airbus A321. The "Baseline Concept" is 47% more efficient regarding energy consumption than our reference airplane. The concept of operations and considerations regarding cabin layout and the technical and financial feasibility show the competitiveness of the eRay in an airline's daily routines proving that the eRay meets the demands specified in the beginning and can in fact be seen as the airplane of the future.

1 Introduction and Market Analysis - Roadmap 2045

Global revenue passenger kilometers (RPKs) have been growing on average by 5.5% in the last decade [1]. This growth rate will only receive global and social acceptance if it can be achieved with a decreasing environmental footprint. Energy production has become more lavish and resource-consuming as well as more incisive to nature. Oil and gas is produced by fracking or the ongoing exploitation of lignite [2]. Reducing the air transport's energy share and meeting the ambitious goals set by the European Commission in Flightpath 2050 and NASA, new aircraft designs are inevitable [3, 4].

At the same time, social change will also impel the demand of future aircraft configurations. By 2045, the world population has exceeded 9 billion humans and more than 60% of that population lives in urban areas [5]. The above-average population growth around Asian cities combined with a fast rising middle class will boost the demand for air travel capacities in the region Asia Pacific [6]. Today, 14 of the 20 most frequently served routes are short haul flights connecting Asian cities [7]. This market promises high economic potentials for aircraft manufacturers and airlines in the next decades and is the key market to our concept [8].

Besides, energy consumption and associated pollutants combined with noise emissions of aircraft are very critical for on ground handling, take off and landing. Aircraft noise has been held responsible for sicknesses of residents [9]. Several hubs like Amsterdam, Zurich and Stockholm have introduced noise charges and others will follow [10, 11, 12]. Extensions at airports such as London Heathrow or Munich Airport have been planned for decades, however it is questionable if they will ever be realized [13, 14]. Hence, airport capacity in North America's and Europe's big airports will remain the same or just see a very slight increase and therefore become a bottleneck for air transport growth. By 2050, the demand for almost 4 million flights in Europe might not be satisfied due to airport capacity constraints [15].

Not only the attitude of residents living close to airports has become more discerning, also the wishes of passengers have undergone a change. Almost 60% of all passengers bypass their local airport and drive further accessing a direct flight [16]. The daily nonstop coast-to-coast services in the United States have more than doubled in the last 20 years [17], in Europe the number of direct flights has grown by more than 110% between 2003 and 2013, whilst the overall air traffic amount has only increased by 25% [18]. Future aircraft concepts have to satisfy the trend for more point-to-point connections, linking smaller airports directly with each other.

The addressed challenges of the previous section form the following requirements for the aircraft concept:

- Saving energy of 60% and more
- Feasible flying over water for at least 3h
- Point-to-Point connection between smaller airports
- Low noise and emissions enabling the extension of airport operating hours
- Affordable manufacturability
- Reducing operating costs

2 Methodology

As a reference the airplane A321-200 WV011 [19] with 93.5t MTOW is selected. The first selection of airplane layouts is made by qualitative means. Afterwards, a quantitative evaluation is made based on an iterative parametric model (see section 2.1). This model implements empirical and quasi-analytical formulas known from literature and is calibrated on the A321. For the final concepts, parameter studies are conducted to optimize performance. Additionally, the calculation is refined by the use of CAD models for zero-drag calculation and structural analysis. Finally, there are three models developed: the A321, a baseline concept and an optimistic concept which can be compared by means of mass, aerodynamics and energy efficiency.

These two different concepts are based on scenario analysis. Some future trends like the development of the global population can be forecast with only little uncertainty, but others like the development and acceptance of new technologies or a change of admission regulations do not allow an equally precise estimation over a time period of 25 years. The baseline scenario represents conservative extrapolation, whereas the best case scenario is more optimistic about technology development, societies' openness towards innovations and minor adaptations of the admission regulations.

2.1 Parametric Model

In fig. 1, a flow chart of the model can be seen. First, requirements are set according to the market analysis in section 1. This information is fed to the Design Chart [20] which sets up the required wingloading and thrust-to-weight ratio. The initial sizing for all three concepts is done with the dimensions of the A321. Afterwards, the propulsion system is sized, aerodynamics are calculated and the refined mass estimation is conducted. This leads to a refined layout, for that the energy consumption (see section 2.1.1) is calculated. As these four topics interact with each other, this procedure has to be iterated several times, until masses, aerodynamics and propulsion sizing finally converge. For refined mass estimation, empirical formulas from [20] are used and for CRP structures corrected by values given in [21]. The aerodynamic calculations are mainly done according to Torenbeek [20] and are described in detail in section 4.2.

For the propulsion system, required cross sections are calculated using 1D compressible isotropic flow equations for calorically perfect gas (see fig. 7). Boundary conditions are set by required thrust, inlet/outlet conditions and total pressure ratio. Four different thrust cases are considered: takeoff, start of climb, top of climb and cruise. Based on this information, η_{prop} for energy consumption and the parasite area of the nacelle for aerodynamic calculation is determined.

2.1.1 Energy Consumption

For energy consumption calculation, the aircraft mission is separated into the flight segments take-off, climb, cruise and descent. Additionally, a reserve is calculated for one go-around. The energy consumption during approach is neglected as no proper way of calculation is found.

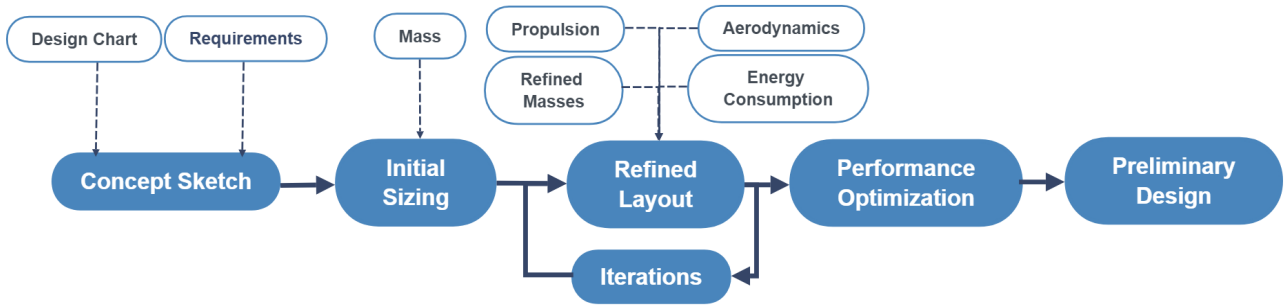

Figure 1: Parametric Model for Performance and Mass Calculation

First, mass dependent thrust and the required time for each section is calculated [22]:

$$T(t) = D(t) + W(t)\sin(\gamma) = M(t)g \cdot \left(\frac{C_W}{C_L} + \sin(\gamma) \right) \quad (1)$$

Combined with velocity, the ideal required energy can be obtained, losses of the propulsion not included:

$$E = \int_{t_{start}}^{t_{end}} T(t) \cdot V_{\infty} dt. \quad (2)$$

For the gas turbines, the energy consumption during descent is estimated using the ICAO fuel burn indices [23]. For the investigated concept the electric fans are only used for yaw control during descent.

For calculating the energy that must finally be delivered by kerosene, the ideal energy is corrected by $\eta_{overall}$. The overall efficiency consisting of η_{prop} , η_{tr} and η_{ec} . η_{prop} is calculated for the Propulsive Fuselage (PF), the Electric Fans (EFANs) and the gas-turbines separately using eq. (4) for an ideal actuator disk and adjusted nozzle. "The energy conversion efficiency, η_{ec} , incorporates the complete chain of energetic conversion" [24]. For the reference airplane, it consists only of the core efficiency as losses in power transmission by the shaft are negligible. For the investigated concepts, it is the product of η_{core} and the total electrical efficiency η_{elec} that accounts for losses of generator, power management system and electrical motors (see section 4.3.4). η_{core} is set according to literature research and GasTurb optimizations described in section section 4.3.2 and η_{elec} is set according to section 4.3.4. The transmission efficiency of the fans is assumed to stay the same, as the fans are smaller, but better methods for optimization through CFD are established to counteract enhanced secondary flow losses. Altogether, η_{ov} is calculated and the total amount of energy is given. Together with energy density of kerosene, the mass of fuel is given for the next iteration.

3 Concept Selection

As requirements are set, different approaches to meet these are evaluated. Major technical topics besides structure are aerodynamic efficiency and overall efficiency of the propulsion with the performance indicators glide ratio (L/D) and overall efficiency η_{ov} .

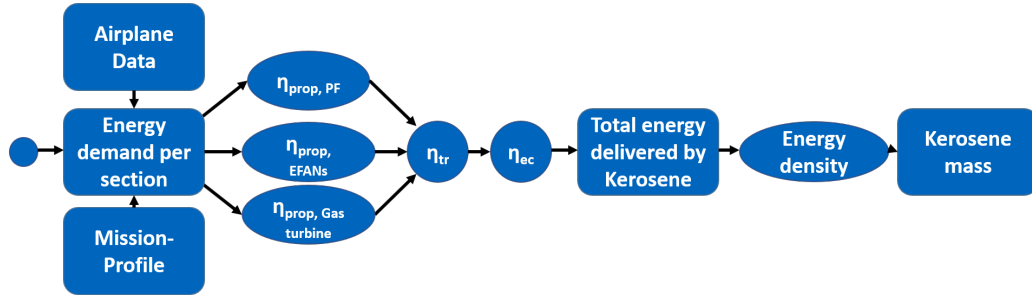

Figure 2: Energy Chart

3.1 Basic Design Consideration

For increasing propulsive efficiency, open-rotor systems, geared turbofans, electric propulsion and turbo-electric propulsion (TEDP) are investigated. All four approaches increase the accelerated massflow, decrease exit velocity and thus increase η_{prop} (see section 4.3.1). This is done, except for the all electric airplane, by increasing the Bypass-Ratio (BPR). The decision for one of these concepts is made on a qualitative basis using a decision table (see fig. 3). This takes among other into account weight, efficiency, noise and potential synergy effects.

	Weight	Prop-Efficiency	Transmission Efficiency	Complexity	Noise	Passenger Acceptance	Synergy Effects	Development Risk	Safety	
Geared TurboFan	-1	1	0	-1	1	0	0	0	0	
Open-Rotor	-1	2	0	-2	-1	-2	0	-1	-1	
Electric Propulsion	-3	3	-1	-2	3	-1	3	-3	2	
Turbo-Electric Propulsion	-2	3	-3	-3	2	0	3	-1	3	
Weighting:	3	5	3	2	3	3	3	2	5	29
Normalized weights:	0,10	0,17	0,10	0,07	0,10	0,10	0,10	0,07	0,17	
	Weight	Prop-Efficiency	Transmission Efficiency	Complexity	Noise	Passenger Acceptance	Synergy Effects	Development Risk	Safety	Score
Geared TurboFan	-0,10	0,17	0,00	-0,07	0,10	0,00	0,00	0,00	0,00	0,10
Open-Rotor	-0,10	0,34	0,00	-0,14	-0,10	-0,21	0,00	-0,07	-0,17	-0,45
Electric Propulsion	-0,31	0,52	-0,10	-0,14	0,31	-0,10	0,31	-0,21	0,34	0,62
Turbo-Electric Propulsion	-0,21	0,52	-0,31	-0,21	0,21	0,00	0,31	-0,07	0,52	0,76

Figure 3: Exemplary Decision Table for qualitative Selection

Open-rotor suffers from an efficiency drop with increasing Mach number, high noise and an increased risk in case of blade-off. By implementing geared turbofan it is complicated to make use of synergy effects as boundary layer ingestion (BLI), as this would affect the core efficiency. In contrast, (turbo-)electric propulsion allows greater design freedom and thus potentially more synergy effects, but at the cost of transmission losses and higher system complexity. For this concept, it is decided to continue with (T)EDP to investigate its synergy effects.

The aerodynamic layout evaluation is made on the assumption of implementing TEDP (see fig. 4). A significant improvement in aerodynamics can be achieved by either drastically reducing wetted area or by laminarization of the flow (LFC). The first approach is implemented effectively by all-wing or blended wing bodies (BWB). However, this type not only requires major changes in production and operation, but also passenger acceptance is critical due to multiple changes, e.g. stronger flight movements [25]. Furthermore, a BWB’s adaptability for family concepts is low compared to conventional layouts. A compromise between conven-

tional and BWB configuration is the double bubble fuselage, that also reduces wetted area per PAX, without significantly reducing passenger comfort. However, the potential for synergistical propulsion implementation and aerodynamic improvement is limited (see section 4.2 for most promising TEDP concept).

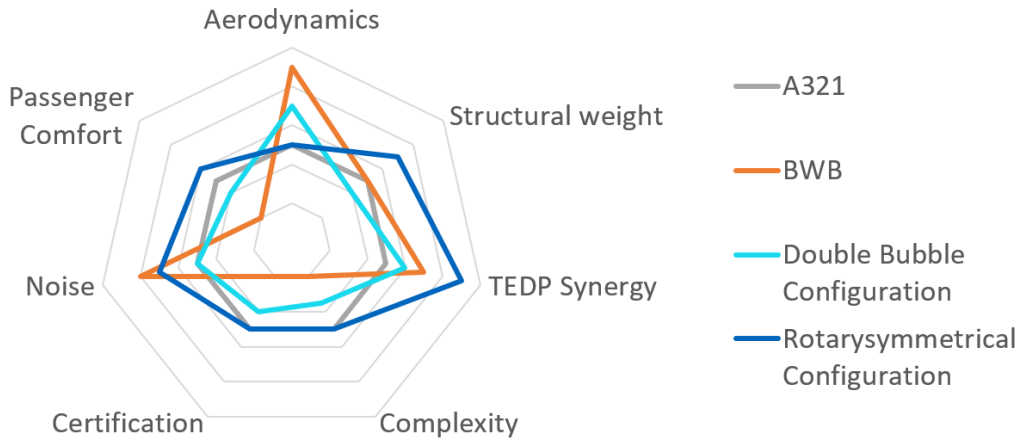

Figure 4: Layout under the assumption of implemented TEDP

According to the previously mentioned arguments, this concept sticks to the conventional fuselage-wing layout. For improved aerodynamics, laminarization of the flow around the wings is implemented.

3.2 Refined Layout

As the approaches to meet aerodynamic and propulsive efficiency are set, the layout has to be considered more closely. TEDP offers great design freedom which inherits several opportunities, but thus requires a well structured approach to evaluate these, especially because of its interference with the aerodynamic layout. A selection of options can be seen in fig. 5.





Concept	Description and Abbreviation
	Aft-mounted fans covering the upper part of a cylindrical fuselage (REVOLVE)
	Tube and wing configuration with fans integrated within a split-wing (SPLIT)
	Tube and wing concept with fans mounted on the upper wing side (WING)
	Cylindrical fuselage with circumferential fan at the aft section (PROPFUS)
	Cross-flow fan embedded into the trailing edge of the wing (CROSS)

Figure 5: Selection of possible TEDP layouts - Originating from Source [26]

According to [26], the Propulsive Fuselage (PF) offers the greatest potential for power savings, as the influence of BLI (see section 4.3.1) is most significant at the aft of the fuselage. Consequently, this concept is selected for implementation. However, the PF performs best if used only for compensating the fuselage-drag, thus a secondary thrust-source is needed. One option is to remain at conventional aircraft configuration using two geared turbofan turbines, but as electric distributed propulsion, contrary to gas-turbines [27], does not have the disadvantage of dropping efficiency when scaled smaller, additional EFANs are also feasible. Remaining configurations that are applicable are SPLIT, WING and CROSS. All three offer the possibility of wake-filling of the wing, CROSS and WING additionally allow BLI. However, transmission efficiency of CROSS and its high relative Mach numbers

make the use for transsonic operating aircraft critical. SPLIT does not allow BLI and its size is limited by the local wing geometry, but by implementing WING, increased interference drag with the wing is critical. Eventually, the WING configuration is chosen, as it allows a higher degree of design freedom.

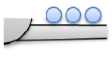
At a later stage of this report it is shown that pure electric propulsion would not be feasible, even if calculated with very optimistic energy densities in the year 2045 (see section 4.3.3), thus gas-turbines are implemented. The gas turbines are placed at the wing tips for load relief, end-plate effect and undisturbed inlet-flow. As they are primarily used for power generation and only deliver 1.2 kN thrust each, OEI is uncritical even if implemented at wing tip.

4 Our Concept: Technical Specification

The approach presented in this paper was primarily to increase the propulsive efficiency using turbo-electric distributed propulsion (TEDP), to improve the aerodynamics using Laminar-Flow Control (LFC) and reduce weight by new materials, a new fuselage concept and active load reduction.

After the evaluation of different possible implementations (see section 3), one concept is investigated in detail and two variants are derived. One variant is a low-risk concept, that is based on a baseline scenario where all admission-requirements of today are met and technology has improved only incrementally, resulting in fuel-saving of 52% compared to 2005. Furthermore, a more optimistic concept eRay is derived, assuming changes in admission as well as changed requirements by passengers and disruptive improvements in key technologies like battery capacity and cooling technologies, resulting in fuel savings of 65%.

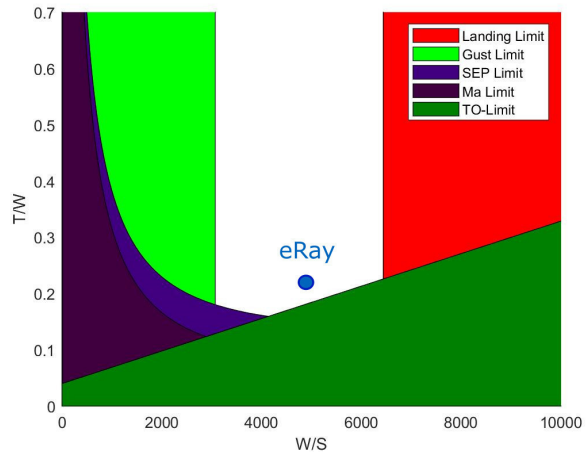

Figure 6: Design Chart of eRay

The optimistic model eRay has quite small take-off mass of 67t and increased wing area, due to the fact that the reduced viscous drag leads to a lower optimum C_L of 0.4. As a consequence, wingloading is relatively small with $4870\text{N}/\text{m}^2$, but as can be seen in fig. 6, still not critical for gusts. The static thrust delivered by EFANs and PF reaches 152kN, meeting the required Thrust to Weight ratio of 0.23. The wing area of 135m^2 as well as the sweep of only 22° is beneficial for high lift at take-off and landing. Additionally, the distributed EFANs on the aft of the wing are used for boundary layer control to avoid flow detachment at high angle of attack and externally blown flaps are implemented behind them (see fig. 7). Therefore, a complex high lift system is avoided.

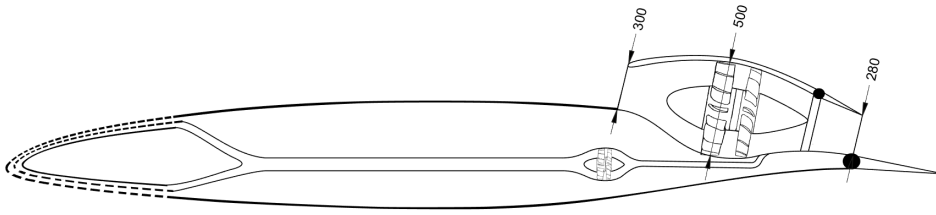

Figure 7: Cross Section of the wing

4.1 Structure and Masses

	A321	Baseline	eRay
Max. TO Mass	93500	75500	67000
Empty Mass	49400	41600	35600
Propulsion total	7006	7696	5582
- Gas turbines	7006	3201	2403
(Generators incl.)			
- EFANs	0	1710	939
- PF	0	952	634
- Converters	0	1831	815
- Refrigerator	0	0	789

Table 1: Propulsion Mass in kg

The wing benefits from the assembly of propulsion, as with gas-turbines and generators placed at wing tips, a reduction in wing root bending moment of 5.5% is achieved compared to conventional placement. To counteract the the moment of the PF at the aft fuselage, the battery is placed in the belly right before the wing for a center of gravity at neutral point. Moreover, the eRay features an active maneuver and gust load alleviation system. The flaps adapting the EFANs outlet cross section to flight conditions and the ailerons are used to reduce loads incorporated by gusts and maneuvers. The ultimate load factor for eRay is consequently reduced from 3.75 to 3.0. As only a horizontal tail is installed in the eRay, the mass of the empennage is reduced (see section 4.4). System mass declines as the hydraulic system is replaced by electric actuators, no APU is necessary anymore, high lift device is more simple and electric power generation and storage is already included in propulsion system and battery.

The propulsion mass increases in the baseline concept from 7.0t to 7.7t due to higher system complexity because of electric motors, generators and converters additional to gas turbines. For eRay, this development is met by the use of superconduction electrical components, reducing propulsion weight to 5.6t. The refrigerator is estimated to increase weight by an additional 70% of the generator or motor that is supposed to be cooled by it [28]. Furthermore, batteries must be installed as buffer for high energy demand at take off and climb. Turbine weight decreases as an effect.

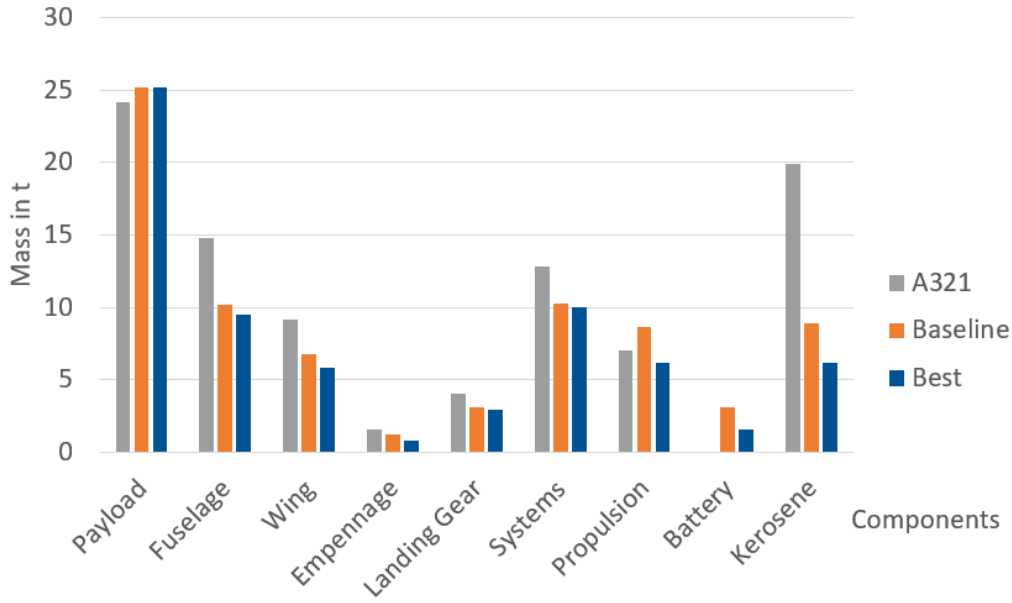

Figure 8: Mass of Aircraft Components

4.2 Aerodynamics

Key indicator in aerodynamics is the glide ratio C_L/C_D , consisting of the lift coefficient C_L and the drag coefficient C_D . The glide ratio of the A321 is calculated to be 17.3, while the eRay has a glide ratio of 22.1. This improvement of aerodynamic efficiency is mainly achieved by holding major parts of the wings's boundary layer laminar using the OA-JTI-1 profiles and LFC, reducing wetted area with the empennage and optimizing induced drag.

Firstly, C_L is determined by a trade off between the wing's viscous and induced drag. The minimum is $C_L = 0.4$, where induced drag equals viscous drag. The wing's area of 135 m^2 is calculated using the force equilibrium in cruise. With a sweep angle of 22° determined in 4.2.1, the taper ratio λ is chosen for an almost elliptical lift distribution to 0.24 [21, 29].

As the next step, the Aspect Ratio (AR) is chosen. Figure 10 shows dependencies of wing mass (WM), wing span (WS) and energy consumption for eRay's fixed wing surface. The trend of the energy consumption points out that a AR of 25 is favorable. However, ground handling and infrastructure is limiting, thus, the AR is set to 10.5, being a compromise between low energy consumption and still being capable of operating at airports as WS of 38m is not exceeded.

Viscous Drag: For a subsonic aircraft, the drag coefficient is the sum of zero drag and induced drag. Zero drag is calculated using parasite drag areas according to Torenbeek [20] as seen in Figure 9. The transition from laminar to turbulent occurs at 60% of the profile's chord for the this concept, as shown in [30]. Together with new empennage, $c_{d,0}$ is improved by 30%.

Induced Drag: The induced drag is calculated by $C_{ind} = k \cdot c_L^2$, with $k = 1/(\pi \cdot AR \cdot e_{eff})$. Due to the end plate effect, the Oswald factor e_{eff} improves by 7.8% using following equation: $e_{eff} = (1 + 2 \cdot h_{turbine}/b)^2 \cdot e$ [31]. Compared with the A321, the eRay has higher AR, uses end plate effect and especially reduces C_L from 0.58 to 0.4, resulting in a reduction of induced drag of 56%.

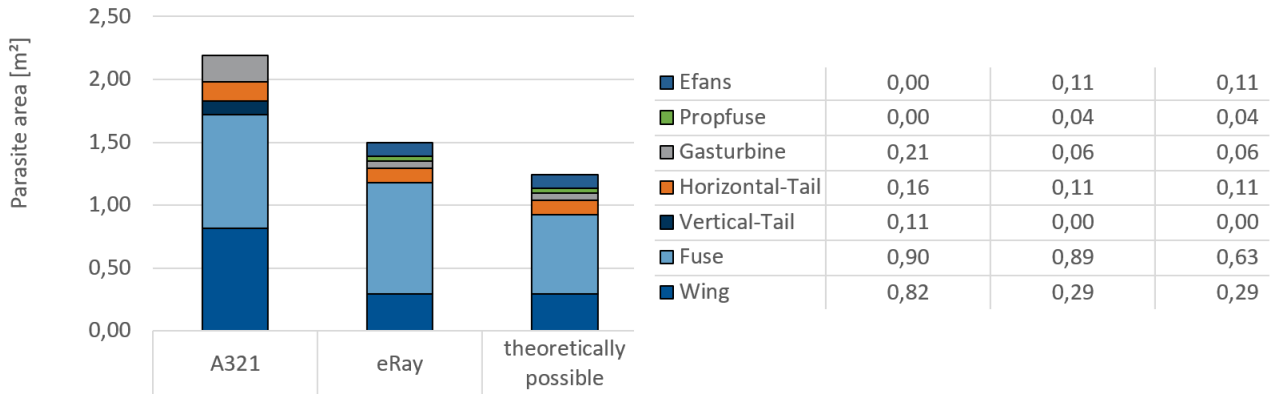

Figure 9: Parasite Areas

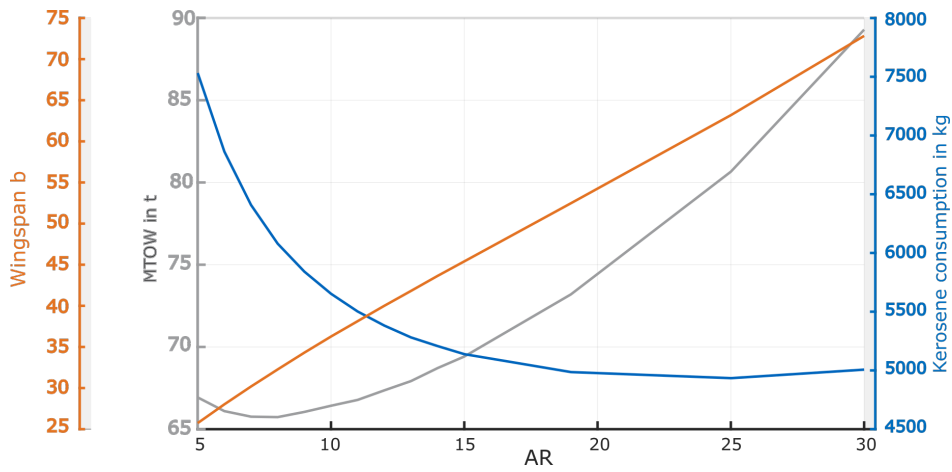

Figure 10: WS, MTOW and kerosene consumption over AR

4.2.1 Laminar Flow Control

Instability mechanisms leading to transition from laminar to turbulent flow are Tollmien-Schlichting instability (TSI), Cross-flow instabilities (CFI) and Attachment-line transition (ALT). Suction of air at the first 20% of wing chord can control sweep-induced crossflow disturbances of highly swept wings, that are usually required for flying at high subsonic and supersonic speeds. Hence, removing a small amount of the boundary layer air by suction through porous material is applied. Furthermore, suction at the leading edge can avoid ALT. As shown in flight and wind tunnel experiments, TSI predominates on aircraft wings with moderate leading-edge sweep angles $\Lambda_{LE} < 25^\circ$ [32].

With profile OA-JTI-1 the laminar bucket reaches a C_L of up to 0.5, providing eRay’s wings with a tolerance before transition [30]. Using natural laminar airfoils, the shock and pressure recovery occur at high chord length. Shock strengths are limited by a local Mach numbers of 1.2 to prevent shock-induced separation of the laminar boundary layer. To ensure attached flow, the maximum slope of the aft pressure gradient $\Delta c_p / \Delta(x/c)$ is kept below 3.0. The airfoil’s Ma_{Design} is 0.724 [30]. As eRay cruises at Mach 0.78, the sweep angle is determined to 22° reducing the effective Mach number to 0.724.

As the airfoil’s design Mach number is calculated in [30] for a different Reynolds number and

C_L , the Korn equation (eq. (3)) is used to determine if wave drag is still acceptable. With a thickness of 0.14, the Korn equation leads to a divergence Mach number of 0.725, that is very close to the design Mach number [33]. Thus, the chosen wing represents a good trade-off between high velocity and low wave drag.

$$Ma_{dragdivergence} = \frac{K}{\cos(\Lambda_{LE})} - \frac{t/c}{\cos(\Lambda_{LE})^2} - \frac{c_{l,design}}{10 \cdot \cos(\Lambda_{LE})^3} = 0 \quad (3)$$

K in eq. (3) is assumed to be 0.87 taken from data of the NACA 6 series [30].

A pressure difference Δc_p of 0.2 is applied between the wing surface and the suction chamber [34]. The pressure difference of the Wing can be calculated to 4.5 kPa. The suction speed u_s is defined as $c_Q \cdot U_\infty$ where c_Q is the suction coefficient [35]. Integrating the suction coefficient over the chord and multiplying with U_∞ delivers the mean speed of 0.078 m/s. With that the suction massflow over the whole wing can be calculated to 1.5 kg/s. Energy consumption can be calculated to 20 kW. As a result, a reduction of zero drag of the wing of 50% is achieved by the LFC for the eRay, leading to an overall better (L/D) of 26% due to LFC, which is in accordance with literature [36].

4.3 Propulsion

In both concepts, instead of producing thrust with conventional gas turbines, thrust is decoupled from the core engines. The core engines drive generators to produce electric energy. The turbines are placed at the wing tips, as in case of OEI only a little yawing-moment results. The EFANs are placed on the trailing edge of the inner top wing (see fig. 22), thus enable better propulsive efficiency, enhanced Laminar-Flow-Control and super-circulation [37]. A spacing of 1.5m from the fuselage is provided to avoid interference with the PF. The PF is placed at 95% fuselage-length to take full advantage of BLI.

Due to multiple redundancy by the PF and multiple EFANs, in case of OEI the yawing moment can be fully compensated by the remaining fans, resulting in a smaller vertical tail [29] for the Baseline. Additionally, the EFANs are responsible for yaw-control and thus replace the rudder. For the eRay, certification changes are assumed to enable neutral directional stability. Thus, complete vertical tail and rudder is replaced by a horizontal tail with dihedral angle and by thrust variation of EFANs. Additionally, the drag of the fuselage is compensated by an electric turbine at the end of the fuselage (Propulsive Fuselage PF), further increasing propulsive efficiency. The EFANs have the disadvantage of increased wetted area due to the space in between them. This is counteracted by filling this space with the actuators of the flaps, replacing flap track fairings.

In contrast to the common approach, following advantages are implemented due to TEDP:

1. Electric engines can be scaled smaller without significant efficiency loss. Thus, they can be distributed without penalty. In this concepts, electric fans are placed at the trailing edges of both wings and at the end of the fuselage (see fig. 22).
2. EFANs are put into the boundary layer (BLI), thus improving η_{prop} by reduced ram-drag and wake-filling, without disadvantages in core efficiency [26]

3. A battery is used as a buffer for high energy demands. Consequently, the core engine can be scaled smaller and is optimized for one design point. Additionally, NOx and carbon black-emission near populated areas during taxiing, take-off and landing are completely avoided using the required power from the battery.
4. In case of OEI of a gas turbine, thrust is still provided by EFANs and battery.
5. High redundancy, as 20 EFANs plus one PF are used.
6. Replacement of rudder and vertical tail in best case concept allows reduction in wetted area.
7. Due to the placement on the rear top of the wings, super-circulation is implemented, avoiding a complex and noisy high-lift device [38].

As a result, the overall efficiency increased by 25% for the Baseline and by 50% for the eRay. The overall improvement consists of 29% more efficient gas turbines and an improvement in propulsive efficiency of 23%.

4.3.1 Propulsive Efficiency

Propulsive efficiency is defined as the ratio of thrust performance to usable power. For an adjusted nozzle, the ideal propulsive efficiency η_{prop} can be stated as

$$\eta_p = \frac{T \cdot V_\infty}{P} = \frac{\dot{m}(V_2 - V_1) \cdot V_\infty}{\frac{\dot{m}}{2}(V_2^2 - V_1^2)} = \frac{V_\infty}{V_1 + \frac{V_2 - V_1}{2}}. \quad (4)$$

Propulsive efficiency can either be improved by reducing specific thrust $V_2 - V_1$ or by BLI, with the effect of decreased inlet velocity V_1 [39, 26]. The first approach leads to increased massflow, reduced total pressure ratio PI and increased inlet area and nacelle drag. Thus, determining the optimum specific thrust is a trade-off between those. In fig. 11, the optimum for kerosene consumption can be determined by PI=1.15 or a specific thrust of 41 m/s respectively. The second approach leads to higher specific thrust. However, for the EFANs the effect is marginal, as the boundary layer is thin, leading to an improvement of 1.7% of η_{prop} .

In contrast, the PF profits significantly from BLI, as boundary layer thickness at the aft fuselage is 0.46m. This value determines the inlet height according to [40]. For best performance, the thrust of the PF is set to compensate the impulse loss of the fuselage in cruise.

With this propulsion system, the combined η_{prop} could be increased by 23% compared to the CFM56.

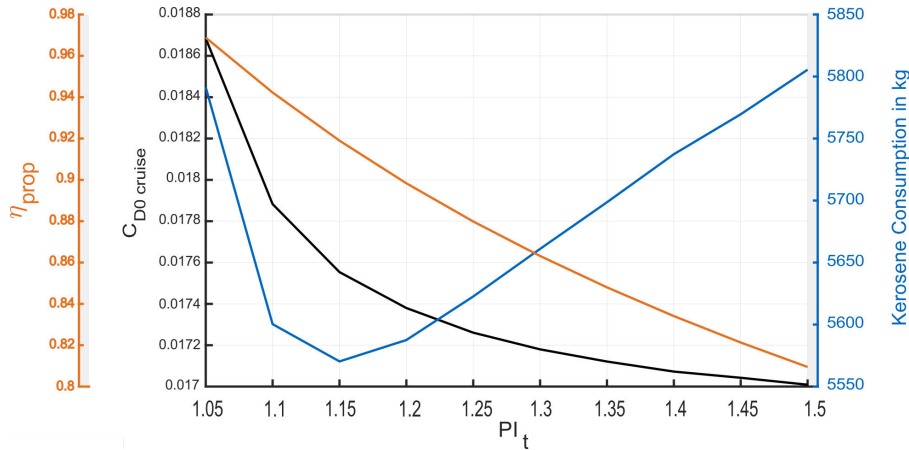
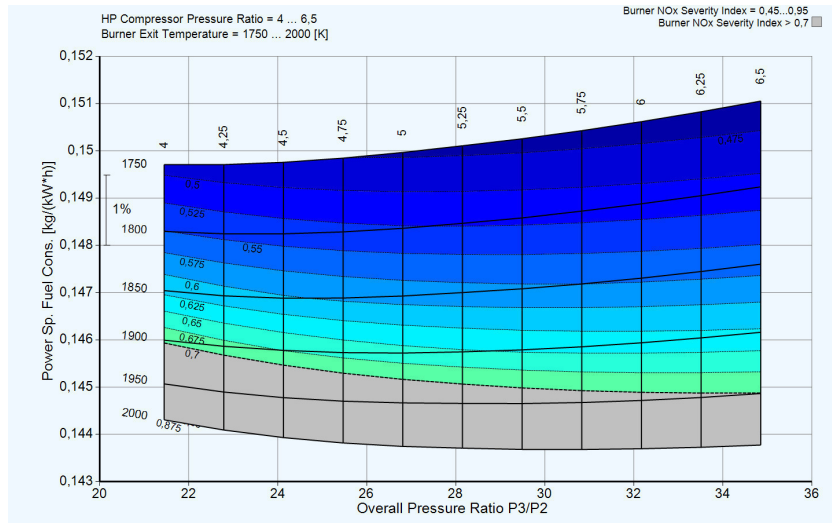

Figure 11: Propulsive efficiency, zero drag and kerosene consumption over total pressure ratio of EFAN

4.3.2 Optimizing Turbine Technology

To evaluate the most efficient engine technology, several concepts were compared in GasTurb12. The most promising is a core concept presented by EU funded research program LEMCOTEC using both, an intercooler in between the compressors as well as recuperation, called Intercooled Recuperated Aero Engine (IRA) and promising real PSFC savings of 20% compared to turbofan configurations. [39, 41, 42]. Unlike traditional engine designs, Power Specific Fuel Consumption (PSFC) does not improve with a higher Overall Pressure Ratio (OPR), but deteriorates slightly [39]. Even if the primary goal is reducing the energy consumed, NO_x emissions are not completely neglected for the turbine's design. According to the Aeronautics and Space Engineering Board, NO_x emissions are a nonlinear function of P_3 and T_3 [43]. Hence, the IRA concept is beneficial to reduce fuel burn and NO_x emissions at the same time. In addition, the flight Mach number has almost no negative influence on the core efficiency [39]. Therefore, the intercooler and recuperator are integrated to eRay's turbines. Boosting combustion temperature is the most effective way of boosting the core efficiency. Today, turbines with a Turbine Entry Temperature (TET) of 1850 K are already in service e.g. the M88-2, engine of France's Rafale using ceramic coating on the turbine blades [39]. With a yearly improvement of 12K in TET over the last decades, the assumption of TET of approximately 1840K and a burner temperature of 1900K for eRay' turbines has two supporting reasons [39]. For the baseline scenario a less optimistic combustion temperature of 1800 K is assumed.

Fig. 12 shows the turbine's performance data at cruise (Mach 0.78, FL 330, ISA conditions). Results of a multi-parameter optimization in GasTurb12 show optimal PSFC for an OPR of approx. 25 in fig. 12. However, the variation of PSFC within an OPR between 22 and 30 is less than 2 %. At the same time, a higher OPR of 30 promises NO_x savings of 2 %. To select an optimal Design Point (DP), PSCF is plotted against SP in fig. 12 (b): With an increasing PSFC the SP rises, meaning a conflict of interest between a low PSFC and a high SP. The SP increases by about ten times the percentual magnitude of the PSFC rise. Therefore a slight deviation of around 2 % from the optimal PSFC was chosen to be eRay's DP. That offers a higher SP and consequently smaller turbines inducing less aerodynamic drag as well as a better NO_x Emission Index. The OPR is 29.5 at DP; the DP is plotted in fig. 12 (b).



(a) PSCF vs OPR

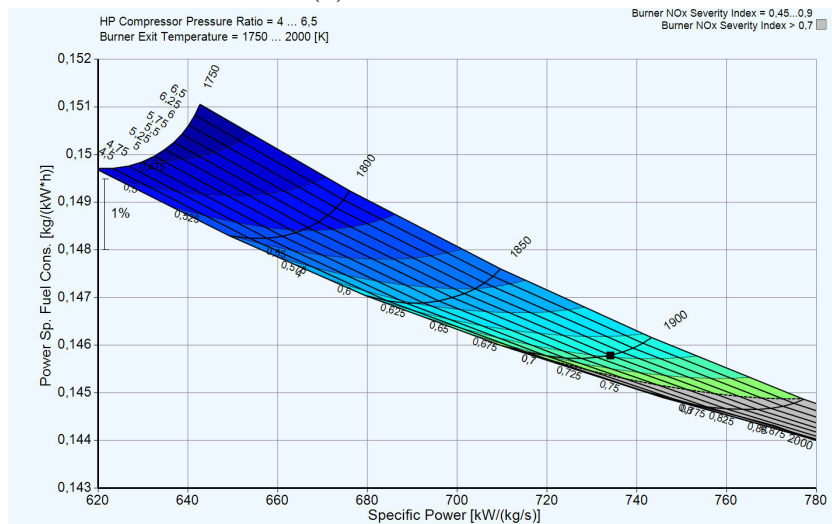

(b) PSCF vs SP

Figure 12: Turbine’s performance data

The NO_x is slightly less than 0.65. However, new combustion technologies as the Rich-Quench-Lean and Lean Premixed Prevaporised combustion offer chances of significantly reducing NO_x emissions by up to 85% [39, 44]. The new combustion technologies are not modelled in Gas-Turb12 and therefore, NO_x are regarded as less critical since they can be significantly reduced.

An overview of the engine’s data at cruise for both scenarios can be found in Table 2. The core efficiency improves for the eRay by 29% compared to A321.

Regarding the engine’s operation, the start up process is also considerably slowed down compared to a regular turbofan. As a consequence, lower temperature gradients and transient centrifugal forces are applied on the engine. The constant TET and the slower start up process will contribute to a significant reduction of wear of high temperature parts like blades in the turbine and to less maintenance, see section 6.3 [45].

	Power [kW]	OPR [-]	T4 [K]	TET [K]	PSFC [kg/(kWh)]	η_{Core} [%]
Base	3521	29.5	1900	1838	0.146	57.3
eRay	5015	23.9	1800	1741	0.148	56.3

Table 2: Single Engine data

4.3.3 Battery System

The batteries deliver energy during takeoff and for the first part of climb, as well as they replace the auxiliary power unit (APU). Until 2010, battery density has improved by 7% p.a. [40]. Combined with lithium ion batteries featuring a capacity of 335 Wh/kg available in 2010, extrapolation suggests a density of more than 2500 Wh/kg by 2040 [46]. However, this assumption is too optimistic, as there are lower theoretical limits for Li-ion batteries, and promising announcements could not be met and the last European technology group quit the market recently [47].

The theoretical limit for Li₂S/Si batteries is 1550 Wh/kg, though the typical realistic battery density is approximately half of the theoretical limit [46]. Consequently, the baseline scenario assumes a conservative estimation of half of the theoretical limit: 800 Wh/kg. eRay features a higher density of 1400 Wh/kg, assuming a breakthrough in battery technology as Lithium-Sulfur and Lithium-Air combinations offer high potential densities [46, 48].

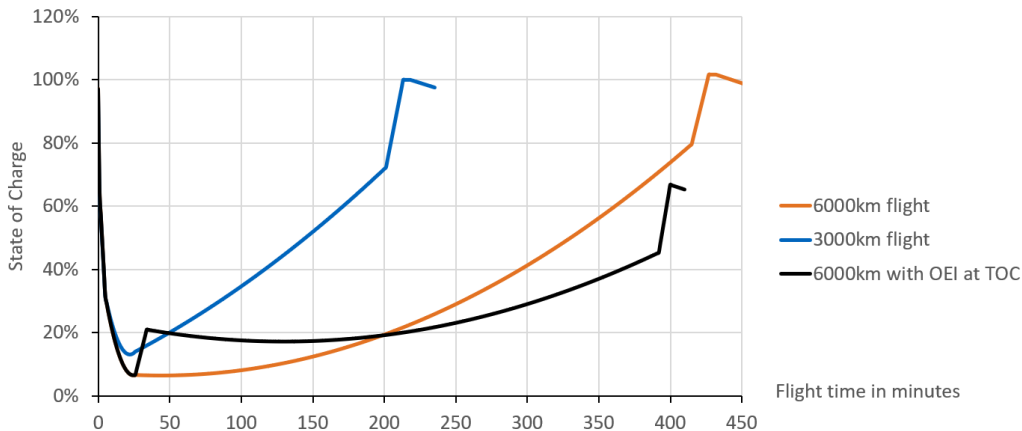

Figure 13: Battery Capacity during flight time

Figure 13 shows the state of battery charge during flight, the blue line is a flight of 3000km with the single class configuration, the orange line representing the same aircraft configuration flying 6000km. During climb, the 6000km configuration is heavier and therefore needs more energy. As a consequence, it has less remaining energy in the batteries as it reaches Top of Climb (TOC). During the longer cruise duration, the batteries can be charged slower than for a 3000km mission. With ongoing flight duration, the eRay gets lighter and less energy is required for propulsion as eRay climbs steadily. More excess power can be transferred to the batteries. The remaining 20% to 25% are charged during descent, when eRay glides and uses the full energy delivered by the engines for charging. From 2000m altitude onward, the gas turbines are switched off and the last kilometers are powered by the batteries only. The black line shows an One Engine Inoperative (OEI) event at the most critical point: TOC. The batteries

are almost emptied and eRay descends to FL 165 immediately. Air speed is reduced to Mach 0.56 continuing operation at optimal C_D/C_L ratio and increasing engine's power. Under these conditions, the batteries deliver auxiliary energy until enough fuel is burnt and the minimum of the black curve is passed approx. 180 min after take off. From now on, the remaining engine provides enough power for propulsion and is even capable of charging the batteries. The black line displays that eRay will exceed the requirements for an Extended Operations of ETOPS 180.

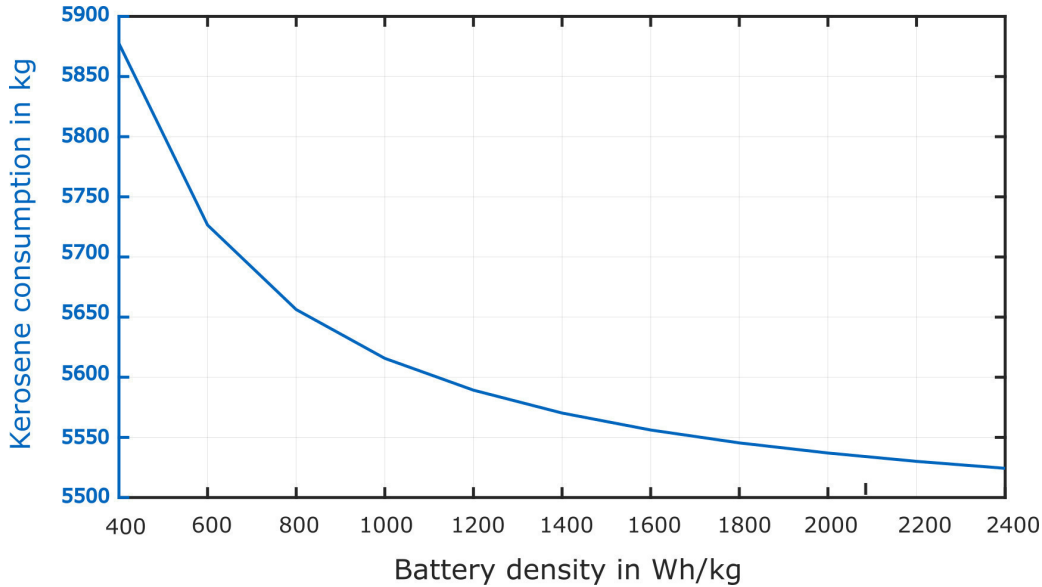

Figure 14: Sensitivity towards battery density

Figure 14 shows the total energy consumption and the battery mass plotted against the battery density of eRay with 200 PAX and a 6000km range. Even if available, batteries with ultra high energy densities of 2500 kWh/kg or higher achieve a maximum total energy cut of only 2 percentage points compared to eRay's 1400 kWh/kg.

4.3.4 Electrical Components

To reach the goal of high overall energy efficiency of the airplane, an efficient powertrain concept is essential for distributing energy from the gas turbines to the EFANs. Multiple components are needed for the turboelectric propulsion system. The electrical system architecture described in this report can be seen in fig. 15. A generator is attached to a turbine engine that is sitting on the wing tip producing electric energy to power the distributed EFANs. The battery, which is located in the belly of the aircraft, is the second available source of energy. The battery feeds into the power system during taxi, take-off and climb. In flight, it is charged by the turbine and the generator.

Batteries require DC current [49]. The generator next to the engine produces AC current. DC systems have some overall advantages considering cable diameters and electromagnetic tolerance [50]. On the other hand, AC motors tend to be better suited for large scale high power-density applications [24]. The engine speed correlates directly to the current frequency.

Using inverters is a requirement for an overall DC system. Each EFAN is powered by an AC motor and can be controlled individually. The electric system architecture is shown in fig. 15.

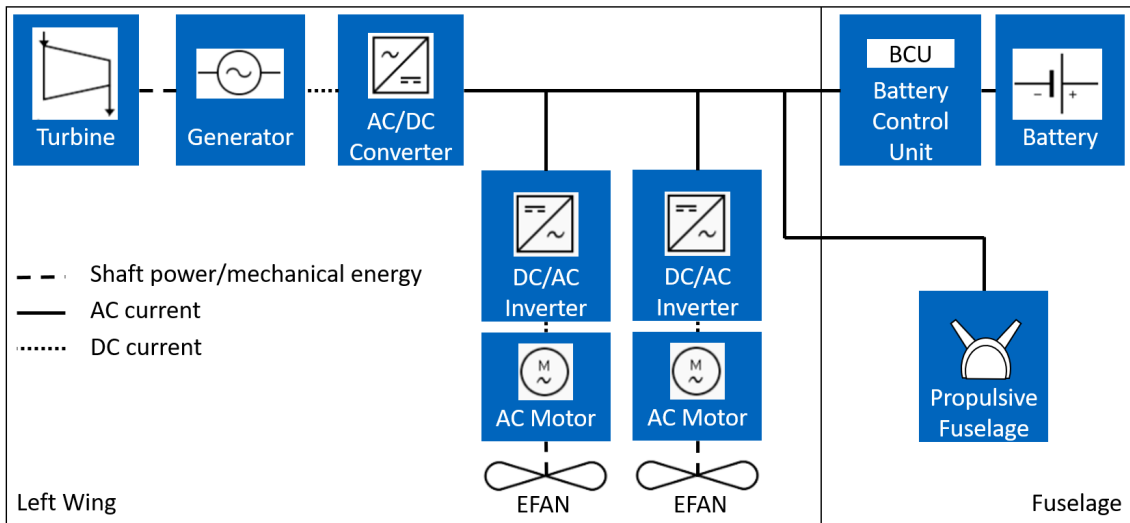

Figure 15: Electric Propulsion System – Schematic arrangement, not to scale

The key factors for optimizing the electrical propulsion system are high power densities and high efficiencies of the components. Conventional motors, generators and inverters can be used, like the "1MW High Efficiency Generator" concept, which was introduced and advertised by the company Honeywell in 2015 and predicts a power density of 8kW/kg for an oil conduction and spray cooled generator. Remarkable is the estimated efficiency of 0.98 compared to current generators running at an efficiency below 0.9 [51]. The propulsion system of the baseline aircraft described in this report is based on conventional components like the Honeywell generator and is estimated to have an overall efficiency of 85% as technology is advancing.

An extremely promising approach to further reducing the weight of the electric propulsion system are current developments in the field of cryogenically cooled superconducting components. Providing a suitable heat sink for superconducting elements within the electrical system may lead to better power densities for generators, motors and inverters as superconducting materials do not have any remarkable electrical resistance below a certain temperature [37]. This enables a high current to run through only small diameter wires and promises "light, compact, very efficient motors and generators" [37].

A study by the Royal Aeronautical Society in London mentions the possibility to reduce the weight of the components by half when using superconducting materials [52]. This is backed by a Bauhaus Luftfahrt study predicting power densities of motors and generators to improve from 10 kW/kg to 20kW/kg until 2035 [53] - which is more than twice the predicted power density of the Honeywell 1MW High Efficiency Generator [51].

The AC motors of the EFANs require inverters like the ones based on Solid State Power Converters (SSPCs). These inverters are currently operating at an efficiency of 95% and a power density of 10 kW/kg [53, 54]. A NASA contract project predicts power densities of 25kW/kg compared to the 10kW/kg at the moment and efficiencies of 99.5% for combined inverter and cryocooler systems [54].

The potential of superconducting components is undisputed. The big challenge lies within supplying the necessary heat sinks to reach the temperatures mentioned above required by the superconducting materials. This may be achieved in different ways: Either by using liquid hydrogen (that could also be used to fuel the aircraft) or by using a refrigerator system with a coolant like nitrogen [37]. The aircraft design described in this report does not include hydrogen but conventional jet fuel. Carrying an extra hydrogen fuel tank increases the complexity of the aircraft and leads to further difficulties like hydrogen embrittlement as described in [55]. The design introduced in this report focuses on refrigerator systems. These systems inherit a complex trade-off: On one hand, they enable the use of superconducting HT components, which leads to high power densities and efficiencies. On the other hand, they increase the complexity and weight of the aircraft design which might annul the advantages. The technological development of refrigerator systems in the next 20 years is extremely uncertain [37].

Due to the high uncertainty of the development of refrigerator systems and the possible difficulties regarding weight and complexity of the cryocooler, the baseline concept was calculated with parameters of conventional electric components. The eRay is more optimistic about these developments and has a refrigerator system using nitrogen to profit from the high efficiencies and great power densities of superconductors.

4.4 Control and Stability

The baseline concept is equipped with conventional empennage and control surfaces in aerodynamic stable configuration. To enhance energy efficiency, the eRay is designed for neutral lateral-directional and longitudinal static stability. Consequently, fly by wire with a control system to avoid uncontrolled flying conditions is implemented. Additionally, the rudder is replaced by thrust variation of EFANs for directional control. As requirements for directional stability are lowered, the horizontal tail is implemented with dihedral angle Γ for neutral directional stability. Consequently, no vertical tail is assembled. This feature does not meet regulation CFR Part 25, however, the FAA issued a special condition for the Airbus A350, allowing it to operate in neutral state, if special requirements are met [56]. The estimation of dimensions of control surfaces and the thrust that must be provided for control is described in following part and is derived from Raymer [21]:

First, the horizontal tail area is determined to meet neutral stability criterion $C_{M\alpha} = -C_{L\alpha}(\bar{X}_{np} - \bar{X}_{cg}) = 0$. After determining the dihedral angle of the tail for directional stability, it is resized according to $S_{h,re} = \frac{1}{\cos(\Gamma)}S_h$ to $29.7m^2$ [57].

For directional static stability, a term for thrust variation is added and the term for the vertical tail is replaced by one for the horizontal tail with a dihedral angle:

$$C_n = C_{n\beta_w}\beta + C_{n\delta_a}\delta a + C_{n\beta_{fus}}\beta + \sin(\Gamma)C_{n\beta_h}\beta + \frac{\Delta T\bar{Y}_p}{qS_w} \quad (5)$$

The horizontal tail effectiveness $C_{n\beta_h}$ can thus be taken from horizontal tail calculation. To meet the requirement of neutral directional stability, $\frac{\delta C_n}{\delta \beta} = 0$, cruise is investigated, being the most critical condition due to a small stabilizing effect of the wing. With eq. (5), the minimum required dihedral angle is given with 19.9° for a horizontal tail area of $27.9m^2$.

The roll moment in coefficient form is given in eq. (6):

$$C_l = C_{l\beta w} \cdot \beta + C_{l\delta a} \delta_a + \sin(\Gamma) C_{l\beta h} \cdot \beta \quad (6)$$

The coefficients in eq. (6) are calculated for a given geometry and aileron placement using empirical formulas. Longitudinal stability is present if $\frac{\delta C_l}{\delta \beta} = C_{l\beta w} + \sin(\Gamma) C_{l\beta h} < 0$. This condition is given because both terms of the sum are negative, as the wing has positive sweep and the horizontal tail has an upward dihedral.

Situations of concern for stability are one sided thrust collapse and crosswind landings [21]. The first issue is of no concern due to multiple redundancy of 21 EFANs. However, crosswind landings must be considered. Crosswind landings equal a sideslip with $\beta = 11.5^\circ$, that results in coupled yaw and roll moment. The roll moment is counteracted by ailerons, the yaw moment by thrust variation. The aileron deflection is set to 20° , resulting in aileron dimensions and placement shown in fig. 22.

Thrust variation is calculated using eq. (5). C_n must be zero for stationary flight, resulting in $\frac{\Delta T \bar{Y}_p}{q S_w} = 0.0305$ or $\Delta T = 30.8 \text{ kN}$ respectively. The ΔT is achieved by increasing thrust by 15.4 kN on the side exposed to the approaching flow and reducing it by 15.4 kN on the other side, keeping total thrust constant. This is done automatically by the control system.

4.5 Energy Consumption

	A321	Baseline	eRay
Takeoff	2.94	1.62	1.28
Climb	7.35	5.22	4.51
Cruise	71.91	46.07	33.78
Descent	2.27	0.01	0.01
Mission	84.47	52.92	39.57
Kerosene fuel in kg	15881	8055	5782
Kerosene/PAX/100km in l	2.36	1.14	0.82
Improvement	/	51.7%	65.3%

Table 3: Energy Consumption per Segment in MWh

the EFANs are shut off. Note, that the given values represent the needed energy per segment, and that this is decoupled from the core turbine as a battery as buffer is used. In descent, the gas turbines produce electric power even though power consumption is zero.

Using the method described in section 2 with masses and efficiency coefficients calculated in section 4, the energy consumption per segment is calculated in table 3. The mission is set according fig. 18 for a distance of 4200km. In all cases, cruise contributes the major part with approximately 85% of overall energy consumption. During descent, in both developed concepts the energy consumption is marginal as

4.6 Cabin Concept

Today, the first concept of virtual windows is entering service within the new First Class in Emirates' Boeing 777-300ER [58, 59]. By 2045, eRay's windowless cabins will have gained wide acceptance by passengers, airlines the crew. The window mock ups in the cabin are underlaid with high definition Organic Light Emitting Diodes (OLED) Displays to create a feeling comparable to a fuselage with windows [60].

The EASA CS-25 requirements concerning minimum aisle width and for three 'type A' and two 'type I' emergency exits per side for more than 200 PAX are met and shown in figs. 16 and 17 [61]. Guaranteeing safe evacuation during an emergency requires an outside view for the crew as each emergency exit "must have means to permit viewing of the conditions outside the exit when the exit is closed" according to Part 25 of FAA regulations [61]. Therefore, the doors and emergency exits will provide windows to ensure undisturbed vision for evacuation [61]. Independent of the seating configuration, the belly is able to store a total of ten LD-3 45W containers.

eRay is offered with different seating options, three of them are shown:

- Single Class with Economy Seats: 200 seats are placed in a 3-3 conventional layout. The legroom distance and the passengers area is comparable to today's Airbus A321 layout.
- High density configuration: Premium Economy, Economy Slim. The ultra high density configuration can transport 222 PAX using Economy seats as well as Economy Slim seats for a 3000km range configuration. The Economy Slim seats offer a more upright seating experience for the passengers to reduce seat spacing and make use of the dead volume above the heads of the passengers. Economy Slim reduces the distance between rows to approximately 80% of the regular seats [62, 63, 64]. Fitting these seats with the height of 153cm requires a slight shift of the aisle off center, see fig. 17. On the Economy Slim side of the aisle, the storage volume for carry-on luggage is not reduced compared to Economy, but even increased by more than 30%, paying attention towards the importance of hand luggage for passengers. The EASA CS-25 requirements concerning minimum aisle width and for three type A and two type I emergency exits per side for more than 200 PAX are met and shown in fig. 16.
- Three Class Configuration: Business, Premium Economy, Economy Slim. The three class configuration features a traditional layout for a medium range aircraft. It has eight Business class, 87 Economy and 105 Economy Slim seats.

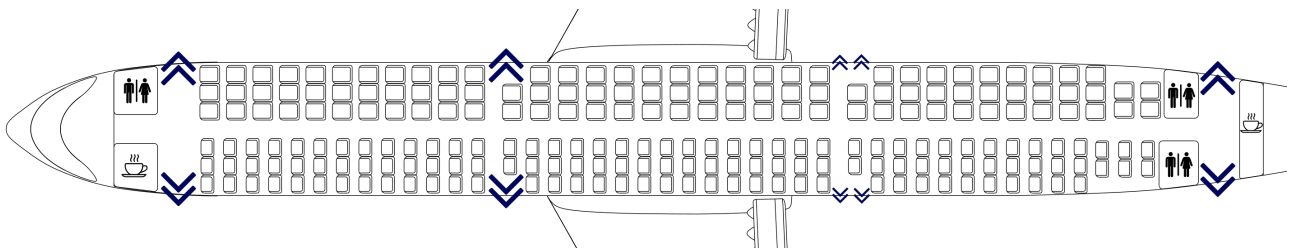

Figure 16: High Density Cabin Layout - Top View

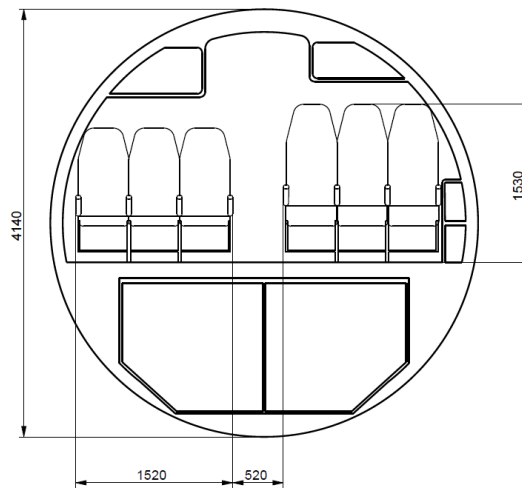

Figure 17: High Density Cabin Layout - Side View

4.7 Summary Baseline and Best Case Concept

With the previously described measurements, the energy consumption of the eRay was reduced drastically by simultaneously improving the mission profile compared to the payload range diagram of A321 (see fig. 18).

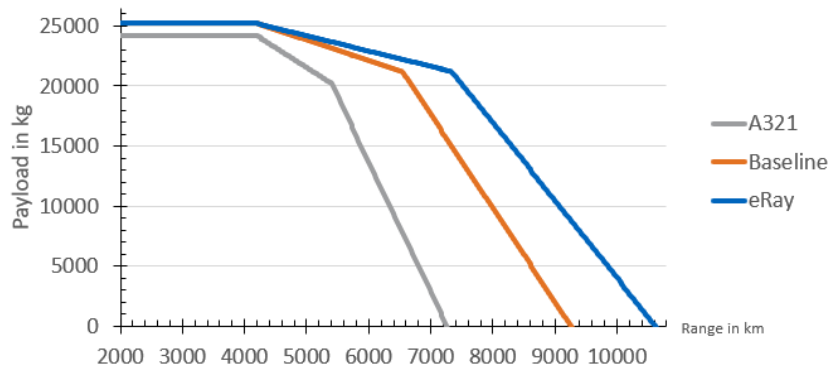

Figure 18: Payload Range Diagram for A321, Baseline and eRay

Section 4.7 provides an overview of the most relevant aspects differentiating the baseline and the more optimistic eRay concept. Also, the resulting savings in mass reduction, (L/D) ratio and the overall efficiency of the propulsion system are shown. These results show the big potential of both, the baseline eRay concept in a rather pessimistic scenario concerning the development of certain key technologies described in section 6.1 as well as the more optimistic eRay variant which offers even higher savings. The following sections use the best case eRay concept as a reference for further considerations like the concept of operations (see section 5) and the comparison to the current best in class reference aircraft Airbus A321.

	Baseline	Best Case
Mass reduction (empty)	16%	28%
(L/D) improvement	23%	28%
Span	36m	38m
η_{ov} improvement	25%	50%
Battery density	800 Wh/kg	1400 Wh/kg
Regulations applied	CS-25	Modified CS-25
Turbine efficiency	0.55	0.57
Windows	Standard Configuration	No passenger windows except for emergency exits
Cockpit Design	Cockpit with pilot assistance systems like head up displays	Single pilot cockpit
Lateral stability and control	Conventional tail and stable	Neutral stable and no vertical tail
Ultimate load wing	3.3	2.7
Electric propulsion system	Efficiency 0.85, conventional components	Efficiency 0.98, superconducting components

Table 4: Baseline and Best Case Design

4.8 Prospect: Aiming for 80% Energy Reduction

eRay consumes 65% less energy than the reference A321. However, its consumption could be decreased further to achieve an overall saving of 74%.

- Extension of the Aspect Ratio: Increasing eRay’s span to 45m means energy savings of 6%.
- Better gust and manoeuvre load reduction system coming closer to the 1G wing concept, which can reduce the safety factor to 1.5 and promises wing weight savings of around 15% compared to eRay’s current wing with a span of 38m leading to savings of 4% [65].
- 30% natural laminar flow around the fuselage reduces eRay’s fuselage drag by 29%. The aerodynamic efficiency of the eRay is improved by 13% leading to an overall improvement of 17% [29].

All those further improvements implemented promise an overall energy cut of 74% compared to the reference A321.

5 Operation Concept

A Concept of Operations (CONOPS) describes a proposed system from the user centered viewpoint of multiple stakeholders. It is meant to demonstrate and communicate system characteristics in an easily understandable way to everyone involved [66].

The overall purpose of the eRay is to enable transport that is safe, cheap and environmentally friendly. There are several stakeholders interacting with the eRay. The following section focuses

on operational characteristics relevant for Passengers (P), Flight Crew (F), Cabin Crew (C), Airlines (A), Airport staff (AS) and people indirectly affected like residents living close to airports (R). These characteristics are categorized in three different phases: planning (Scheduling and Routing), ground handling and in-flight. Operating an aircraft is a very complex process. The three sections mentioned above will be described in a narrative way to break this complexity down to relevant aspects of operating the eRay. The information about the stakeholders mostly affected is added in brackets behind each section to satisfy all the different user perspectives.

Scheduling and routing: Not many airport related constraints are relevant when planning the routing and schedule of an eRay fleet. Only the batteries are used for taxi, take-off and landing leading to neither emissions nor noise regulations being a critical factor for routing. The eRay may operate at airports with night bans if regulations are changed regarding to its way of operating silently and pollution free. Thus, new slots can be offered extending the limited airport capacities. eRay excels the ETOPS 180 criteria, enabling unlimited operations in its key market Asia Pacific and even traversing the Atlantic Ocean on a 6000km mission making it an attractive choice for European as well as North American carriers. (A, AS, P)

Ground handling: The eRay recharges its batteries in flight so no charging infrastructure or battery changing is required during ground handling. The wing span of 38m fits the standard ICAO airport bays using its highly maneuverable landing gear to park oblige in the standard 36m x 36m bay. Deicing trucks are upgraded for cleaning off dusts and mosquitoes of the laminar wings every fifth landing, ensuring pure wing surfaces and highly efficient laminar flow during cruise. (AP, A)

In flight (Take-Off, Climb, Cruise, Descent, Landing): Boarding is simple and efficient due to the eRay's cabin layout. Passengers who booked pleasingly cheap standing seats in Economy Slim need to be monitored by the cabin crew using seat integrated health trackers for issues like circulatory problems. Not everybody may be familiar with the standing seats so a smooth transitioning phase is important to secure social acceptance for the new concept. There are no windows next to passenger seats but passengers are provided with an outside view through HD displays integrated into the cabin walls. The onboard infotainment system allows passengers to connect their smartphone through an interface to exchange information. A voice assistant based on artificial intelligence allows passengers to communicate with the cabin crew and transmit personal preferences like individual temperature sensitiveness and food choices. An innovative lighting concept using natural light helps passengers to overcome jet lag. It creates a soothing atmosphere meeting the demands of people with fear of flying. It is used for guidance during emergency evacuation and may also include airline's corporate identity design features. Emergency evacuation happens through exits meeting current CS25 requirements as stated in section 4.6. Further Human Machine Interface developments were able to overcome the *ironies of automation* [67] and reduce the pilot's workload without affecting situation awareness negatively [68]. The cockpit requires only one pilot as redundancy for monitoring purposes due to the extremely low probability of failure of the autopilot and for aid in an emergency situation [69].

6 Feasibility and Cost Estimation

6.1 Key Technologies

	TRL	Energy-Sensitivity
Laminar Flow Control	7	28.2%
Neutral config. w/o rudder	6	6.5%
Refrigerator	4	13.7%
IRA Engine	4 - 5	12.2%
High Density Battery	4	1.7%
Single-Pilot Cockpit	6	/
Active load reduction	6	1.8%

Table 5: Key Technologies, TRL and Energy-Sensitivity for eRay

In this section, key technologies for this concept are summarized and evaluated according to Technology Readiness Level (TRL) [70]. Furthermore, the sensitivity of eRay regarding each technology is shown through the increase of consumption if not implemented. The neutral configuration is already common in state of the art aircraft, only yaw-control through engines is not implemented yet. However, the control technology of recent UAV proof the feasibility of this concept.

The readiness of LFC is e.g. shown by the Boeing 757 HLFC test flight in 1990 [32]. Engine intercooling was successfully tested on a rig at Chalmers University, Gothenburg, Sweden [71]. Recuperators are tested on a small scale in laboratories as well [72, 73]. Turbines with recuperator have been used in micro turbines on ground applications as in the tank M1A1 Abrams or for energy production [39].

6.2 Manufacturing Costs

Manufacturing costs are compared to the A321 which is listed with a price of 118.3 million \$ [74]. The list price is broken down according to each component's manufacturing costs estimation in fig. 19 [75]. The empennage is estimated 33% cheaper, as it has no vertical stabilizer, the fuselage has no windows and is circular leading to 30% less costs. However, the new propulsion system is more complex and therefore is estimated to be three times the price of A321's. The battery's estimation is two times the price of Tesla's estimated battery costs for 2020 [76].

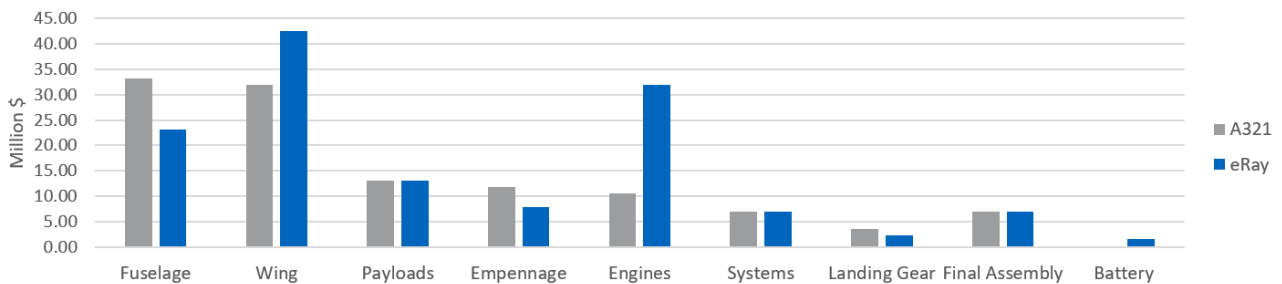

Figure 19: Manufacturing Costs

The overall manufacturing costs are approximately 136,6 Million \$ per unit, meaning 15% higher costs compared to the A321.

6.3 Operating Costs

The Cash Operating Costs (COC) are compared to the A321 and estimated according to the Central Reference Aircraft Data System CeRAS, see fig. 20 [77]. The noise fee of Zurich Airport is added on top as well as the Airport Emission and the CO₂ fees, which are evaluated according to Johanning and Scholz [78]. The fuel price is 0.68\$/kg of June 2018 [79]. Unlike today, the A321 is attributed to Noise Category 3 as noise levels become stricter over time [10].

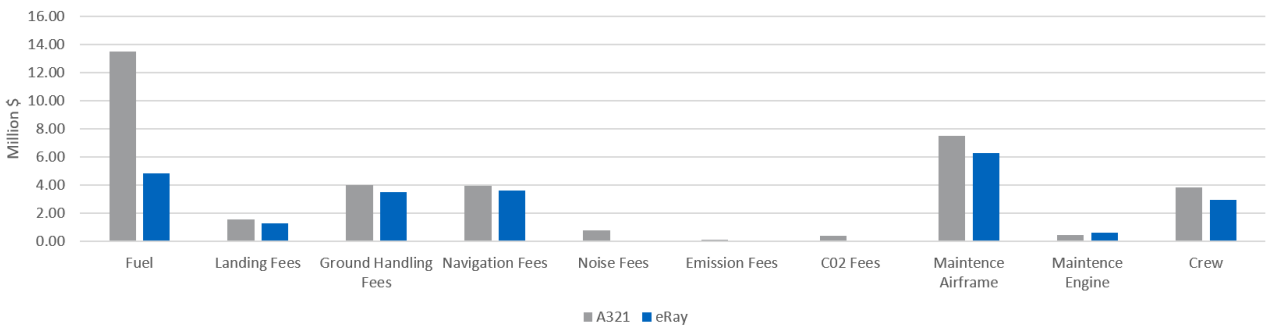

Figure 20: Cash Operating Costs

The yearly COC are 22.2 Million \$, saving 33% compared to the A321. The higher acquisition price pays off within two years operating. For a fuel price of 1.25\$/kg, the COC savings are almost 40% compared to the A321, meaning the COC will equalize the investment in eRay in less than 15 months.

7 Conclusion

7.1 Results

The ambitious requirements to decrease energy consumption by at least 60% on top of other characteristics described in section 1 are fully satisfied by the eRay. Using the synergy effects of TEDP, the eRay combines the advantages of using LFC and the minimum noise potential of battery powered flight close to airports while offering a large degree of system safety. The propulsive fuselage draws full profit from BLI at the aft of the fuselage, leading to even more power savings. A conventional body-wing layout increases compatibility with existing airport infrastructure.

Even the conservative baseline concept calculated with a modest estimation of parameters and design changes turns out to be 25% better in overall efficiency of propulsion compared to the A321. The Best Case eRay variant based on a braver estimation of parameters and design features takes the design one step further to show the new aircraft's full potential. An overall propulsion efficiency improvement of 50% is possible, along with mass reduction of 28% and

an (L/D) improvement of 28%. The Payload Range Diagram in fig. 18 shows that the eRay outperforms the A321 by far. With 20t payload a distance of 7850km can be flown instead of 5400km with the A321, making the eRay an attractive midrange aircraft.

The eRay is well suited for everyday operations. Ground handling is easy as no noteworthy effort is needed compared to the A321. Furthermore, a successful product is not only described through technical specifications but also through the look and feel perceived by the customer. The eRay's cabin layout satisfies the demands of price sensitive passengers booking standing seats in Economy Slim and captivates customers with a modern and functional feel-good atmosphere.

The eRay is waiting for the future to come, flying efficient and silent, being just as elegant as the electric ray that strides through the sea.



Figure 21: eRay in flight

Table of Abbreviations

ALT	Attachment-line transition
APU	Auxiliary Power Unit
BLI	Boundary Layer Ingestion
BPR	Bypass ratio
BWB	Blended Wing Body
CFI	Cross-flow instabilities
COC	Cash Operating Costs
CONOPS	Concept of Operations
DP	Design Point
EFAN	Electric Fan
HT	High Temperature
IRA	Intercooled Recuperated Aero Engine
ISA	International Standard Atmosphere
LCF	Laminar Flow Control
MTOW	Maximum Take-Off Weight
OEI	One Engine Inoperative
OLED	Organic Light Emitting Diodes
OPR	Overall Pressure Ratio
PF	Propulsive Fuselage
PI	Total Pressure Ratio
PSFC	Power Specific Fuel Consumption
SP	Specific Power
SSPC	Solid State Power Converter
TEDP	Turboelectric Distributed Propulsion
TET	Turbine Entry Temperature
TSI	Tollmien-Schlichting instability
TRL	Technology Readiness Level
WM	Wing Mass
WS	Wing Span

List of Figures

1	Parametric Model for Performance and Mass Calculation	3
2	Energy Chart	4
3	Exemplary Decision Table for qualitative Selection	4
4	Layout under the assumption of implemented TEDP	5
5	Selection of possible TEDP layouts - Originating from Source [26]	5
6	Design Chart of eRay	6
7	Cross Section of the wing	7
8	Mass of Aircraft Components	8
9	Parasite Areas	9
10	WS, MTOW and kerosene consumption over AR	9
11	Propulsive efficiency, zero drag and kerosene consumption over total pressure ratio of EFAN	12
12	Turbine's performance data	13
13	Battery Capacity during flight time	14
14	Sensitivity towards battery density	15
15	Electric Propulsion System – Schematic arrangement, not to scale	16
16	High Density Cabin Layout - Top View	19
17	High Density Cabin Layout - Side View	20
18	Payload Range Diagram for A321, Baseline and eRay	20
19	Manufacturing Costs	23
20	Cash Operating Costs	24
21	eRay in flight	25
22	3-sides view above	32
23	3-sides view left	33
24	3-sides view front	33

List of Tables

1	Propulsion Mass in kg	7
2	Single Engine data	14
3	Energy Consumption per Segment in MWh	18
4	Baseline and Best Case Design	21
5	Key Technologies, TRL and Energy-Sensitivity for eRay	23

References

- [1] David Oxley. *Air Passenger Market Analysis December 2017*. IATA. 2017.
- [2] Robert B. Jackson et al. “The Environmental Costs and Benefits of Fracking”. In: *Annual Review of Environment and Resources* (2014). DOI: 10.1146/annurev-environ-031113-144051.
- [3] *Flightpath 2050: Europe’s vision for aviation; maintaining global leadership and serving society’s needs; report of the High-Level Group on Aviation Research*. Policy / European Commission. Publ. Off. of the Europ. Union, 2011.
- [4] National Aeronautics and Space Administration. *Green Aviation: Safeguarding Our Future on Earth Fact Sheet*. 2015.
- [5] *World urbanization prospects, the 2014 revision: Highlights*. New York: United Nations, 2014.
- [6] United Nations. *World Population Prospect 2017 - Key findings & advanced tables*. 2017.
- [7] OAG. *Key facts behind the world’s 20 busiest routes: Based on frequency in the 12 months to February 2018*. 2018.
- [8] Airbus SE. *Global Market Forecast: Growing Horizons 2017 / 2036*. 2017.
- [9] M. M. Haines et al. “Chronic aircraft noise exposure, stress responses, mental health and cognitive performance in school children”. In: *Psychological Medicine* (2001). DOI: 10.1017/S0033291701003282.
- [10] Flughafen Zürich. *Lärmgebühren: Lärmgebühren für Strahlflugzeuge*. Zürich, Schweiz, 2013.
- [11] Swedavia Airports. *Airport Charges: Airport Charges for Swedavia AB*. 2016.
- [12] Amsterdam Airport Schiphol. *Airport charges and conditions 2017: Summary*. 2017.
- [13] Süddeutsche.de GmbH, Munich, and Germany. *Ein fatales Signal für München*. 2018. URL: <http://www.sueddeutsche.de/muenchen/flughafen-ausbau-ein-fatales-signal-fuer-muenchen-1.3869169> (visited on 06/16/2018).
- [14] Taylor, Matthew. *Government faces growing pressure over Heathrow third runway*. Ed. by TheGuardian.com. 2018. URL: <https://www.theguardian.com/environment/2018/jun/15/government-faces-growing-pressure-over-heathrow-third-runway> (visited on 06/15/2018).
- [15] EuroControl. *Challenges of Growth 2013: Summary Report*. 2013.
- [16] FlightView. *Convience & Choice: What Travelers Want Most (And Are Willing to Pay For) Throughout Their Journey: How Airlines and Airports Can Capture More Revenue & Loyalty by Improving the Travel Experience*. 2015.
- [17] Scott McCartney. *The Rare Case Where Airlines and Passengers Both Win*. The Wallstreet Journal. 2018. URL: <https://www.wsj.com/articles/the-rare-case-where-airlines-and-passengers-both-win-1522246644> (visited on 06/19/2018).
- [18] Morphet, H. and Bottini, C. *Air connectivity: Why it matters and how to support growth*. 2014. (Visited on 06/19/2018).
- [19] Airbus SE. *A321 Aircraft Characteristics: Airport and Maintenance Planning*. 2018.
- [20] Egbert Torenbeek. *Synthesis of subsonic airplane design: An introduction to the preliminary design of subsonic general aviation and transport aircraft, with emphasis on layout, aerodynamic design, propulsion and performance*. 1996.
- [21] Daniel P. Raymer. *Aircraft Design*. 4th ed. AIAA education series. American Inst. of Aeronautics and Astronautics, 2006.

- [22] Joachim Scheiderer. *Angewandte Flugleistung: Eine Einführung in die operationelle Flugleistung vom Start bis zur Landung*. Berlin, Heidelberg: Springer-Verlag Berlin Heidelberg, 2008. DOI: 10.1007/978-3-540-72724-8.
- [23] Harshad Khadilkar and Hamsa Balakrishnan. “Estimation of Aircraft Taxi-out Fuel Burn using Flight Data Recorder Archives”. In: *AIAA Guidance, Navigation and Control Conference*. [American Institute of Aeronautics and Astronautics], 2011. DOI: 10.2514/6.2011-6383.
- [24] Seitz A. and Schmitz O. *Electrically Powered Propulsion: Comparison and Contrast to Gas Turbines*. (Visited on 05/26/2018).
- [25] R. Wittmann. *Passenger Acceptance of BWB Configurations*.
- [26] Hans-Jörg Steiner. *Multi-Disciplinary Design and Feasibility study of Distributed Propulsion Systems*. 2012.
- [27] Gregorio Ameyugo, Mark Taylor, and Riti Singh. “Distributed Propulsion Feasibility Studies”. In: *25th International Congress of the Aeronautical Science* (2006).
- [28] Hyun Dae Kim, Gerald V. Brown, and James L. Felder. *Distributed Turboelectric Propulsion for Hybrid Wing Body Aircraft*. 2008.
- [29] Jan Roskam. *Airplane design*. DARcorporation, 2002.
- [30] I. Salah El Din et al. “Natural Laminar Flow Transonic Wing Design Applied to Future Innovative Green Regional Aircraft”. In: *3AF / CEAS Conference "Greener Aviation: Clean Sky breakthroughs and worldwide status"* (2014).
- [31] M. Niță and D. Scholz. “Estimating The Oswald Factor From Basic Aircraft Geometrical Parameters”. In: *Deutscher Luft- und Raumfahrtkongress* (2012).
- [32] Ronald Joslin. *Overview of Laminar Flow Control*. 1998.
- [33] T. Takahashi et al. “Zero Lift Drag and Drag Divergence Prediction for Finite Wings in Aircraft Design”. In: *48th AIAA Aerospace Sciences Meeting Including the New Horizons Forum and Aerospace Exposition* (2010).
- [34] J. J. Thibert, J. Reneaux, and V. Schmitt. “Onera Activities On Drag Redection”. In: *Office National d’Etudes et de Recherches Aérospatiales* (1999).
- [35] M.A.B. van den Berg. “Internal Systems Design for Smart Fixed Wing Technologies using Knowledge Based Engineering”. In: (2010).
- [36] R.D. Joslin. “Aircraft Laminar Flow Control”. In: *Annual Review of Fluid Mechanics* (1998).
- [37] Hyun Dae Kim. *Distributed Propulsion Vehicles*. 2010.
- [38] Williams, Butler, and Wood. “The Aerodynamics of Jet Flaps”. In: *Aeronautical Research Council - Reports and Memoranda* (1961). DOI: 10.1038/190392b0.
- [39] Willy J. G. Bräunling. *Flugzeugtriebwerke: Grundlagen, Aero-Thermodynamik, ideale und reale Kreisprozesse, thermische Turbomaschinen, Komponenten, Emissionen und Systeme*. 4. Aufl. VDI-Buch. Berlin: Springer Vieweg, 2015. DOI: 10.1007/978-3-642-34539-5.
- [40] Arne Seitz and Corin Gologan. “Parametric design studies for propulsive fuselage aircraft concepts”. In: *CEAS Aeronautical Journal* (2015). DOI: 10.1007/s13272-014-0130-3.
- [41] Joerg Sieber. *Overview New Aircraft Engine Core Concepts*. MTU. 2009.
- [42] G. Wilfer et al. “New Enviromental Friendly Aero Engine Core Engines”. In: *18th International Symposium on Air Breathing Engines* (2007).
- [43] Aeronautics and Space Engineering Board - National Research Council. *Aeronautical technologies for the twenty-first century*. 1992. URL: <http://search.ebscohost.com/login.aspx?direct=true&scope=site&db=nlebk&db=nlabk&AN=731>.

- [44] Joerg Henne. *Technologie & Entwicklung von Triebwerken der nächsten Generation*. MTU. 2017.
- [45] M. R. Reyhani et al. “Turbine blade temperature calculation and life estimation - a sensitivity analysis”. In: *Propulsion and Power Research* (2013). DOI: 10.1016/j.jprr.2013.04.004.
- [46] Yuan Yang et al. “New nanostructured Li₂S/silicon rechargeable battery with high specific energy”. In: *Nano letters* (2010). (Visited on 06/03/2018).
- [47] Süddeutsche.de GmbH, Munich, and Germany. *Bosch gibt Forschung zu neuen Batteriezellen auf*. 2018. URL: <http://www.sueddeutsche.de/wirtschaft/e-autos-bosch-gibt-forschung-zu-neuen-batteriezellen-auf-1.3886227> (visited on 06/19/2018).
- [48] G. Girishkumar et al. “Lithium–Air Battery: Promise and Challenges”. In: *The Journal of Physical Chemistry Letters* (2010). DOI: 10.1021/jz1005384.
- [49] Thomas Reddy. *Linden’s Handbook of Batteries, 4th Edition*. New York: McGraw-Hill, 2010.
- [50] M. Becherif and M. Y. Ayad. “Advantages of variable DC bus voltage for Hybrid Electrical vehicle”. In: *2010 IEEE Vehicle Power and Propulsion Conference*. 2010. DOI: 10.1109/VPPC.2010.5729023.
- [51] Cristian Anghel. *Hybrid Electric Propulsion Technologies - 1MW High Efficiency Generator*. URL: [http://www.nianet.org/ODM/presentations/Cristian_Anghel_-_Honeywell_-_Honeywell_Technologies_for_Hybrid_Electric_Propulsion_\(002\).pdf](http://www.nianet.org/ODM/presentations/Cristian_Anghel_-_Honeywell_-_Honeywell_Technologies_for_Hybrid_Electric_Propulsion_(002).pdf).
- [52] Greener by Design Science and Technology Sub Group London. “Air Travel – Greener by Design Mitigating the environmental impact of aviation: Opportunities and priorities”. In: *The Aeronautical Journal* (2005).
- [53] H. Kuhn et al. “Progress and Perspectives of Electric Air Transport”. In: *Proceedings of the 28th International Congress of the Aeronautical Sciences*. Bauhaus Luftfahrt e.V., 2012.
- [54] G.V. Brown. “Weights and Efficiencies of Electric Components of a Turboelectric Aircraft Propulsion System”. In: *AIAA 2011-225, 49th AIAA Aerospace Sciences Meeting including the New Horizons Forum and Aerospace Exposition, 4-7 January, Orlando, Florida, 2011*. 2011.
- [55] Afrooz Barnoush. *Hydrogen embrittlement, revisited by in situ electrochemical nanoindentation*. en. 2008. DOI: 10.22028/d291-22450.
- [56] Federal Aviation Administration. *Special Conditions: Airbus Model A350-900 Series Airplane; Electronic Flight-Control System: Lateral-Directional and Longitudinal Stability, and Low-Energy Awareness*. 2014. URL: <https://www.federalregister.gov/documents/2014/07/25/2014-17575/special-conditions-airbus-model-a350-900-series-airplane-electronic-flight-control-system> (visited on 06/26/2018).
- [57] E. Purser and O. Campbell. *Experimental Verification of a simplified Vee-Tail Theory and Analysis of available data on complete models with Vee Tails: NACA 823*. 1945.
- [58] Emirates. *Emirates Boeing 777 Game Changer: Enjoy HD views*. 2018. URL: <https://www.emirates.com/english/experience/our-fleet/boeing-777/gamechanger/> (visited on 06/17/2018).
- [59] Whitehead, Johanna. *Emirates Airline introduces virtual windows for first class passengers*. Ed. by The Independent. 2018. URL: <https://www.independent.co.uk/travel/news-and-advice/emirates-airline-virtual-windows-first-class-passengers-fuel-costs-a8393266.html> (visited on 06/17/2018).

- [60] S. Bagassi, F. Lucchi, and F. Persiani. “Aircraft Preliminary Design: A windowless concept”. In: 5th CEAS Air & Space Conference. University of Bologna. 2015.
- [61] Federal Aviation Administration. *Federal Aviation Regulations (FAR) Part 25-Airworthiness Standards: Transport Category Airplanes*. URL: https://www.ecfr.gov/cgi-bin/text-idx?node=14:1.0.1.3.11#se14.1.25_1103.
- [62] AvioInteriors. *Aviointeriors Skyrider 2.0 - Aviointeriors*. 2018. URL: <http://aviointeriors.it/2018/press/aviointeriors-skyrider-2-0/> (visited on 06/28/2018).
- [63] Tamara Hardingham-Gill and CNN. *Will new stand-up airplane seat take off?* 2018. URL: <https://edition.cnn.com/travel/article/standing-up-airplane-seat/index.html> (visited on 05/27/2018).
- [64] Dan Milmo. *Ryanair plan for standing-only plane tickets foiled by regulator*. Ed. by The Guardian. 2012. URL: <https://www.theguardian.com/business/2012/feb/28/ryanair-standing-only-plane-tickets-regulator> (visited on 06/28/2018).
- [65] Cord-Christian Rossow, Martin Hepperle, and Heiko Frhr. von Geyr. *The 1g-Wing, Visionary Concept or Naive Illusion*. Bericht des Instituts für Aerodynamik und Strömungstechnik, Institut für Aerodynamik und Strömungstechnik, DLR. 2016.
- [66] IEEE - Institute of Electrical and Electronics Engineers. *IEEE Guide for Information Technology - System Definition - Concept of Operations (ConOps)*. doi:10.1109/ieeestd.1998.89424. 1998.
- [67] Lianne Bainbridge. “Ironies of automation”. In: *Automatica* (Nov. 1983). DOI: 10.1016/0005-1098(83)90046-8.
- [68] D. Comerfeld and et al. *NASA’s Single-Pilot Operations Technical Interchange Meeting: Proceedings and Findings*. NASA. 2013.
- [69] Joel Lachter and et al. *Towards Single Pilot Operations: Developing a Ground Station*. NASA. 2014.
- [70] NASA. *Technology Readiness Level Definition*. URL: https://www.nasa.gov/pdf/458490main_TRL_Definitions.pdf (visited on 06/27/2018).
- [71] Xin Zhao. *Aero Engine Intercooling: Conceptual design and experimental validation of an aero engine intercooler*. 2016.
- [72] Mario L. Ferrari et al. *Recuperator dynamic performance: Experimental investigation with a microgas turbine test rig*. 2011. DOI: 10.1016/j.apenergy.2011.07.016.
- [73] Kyu Hyung Do et al. *Experimental investigation on the pressure drop and heat transfer characteristics of a recuperator with offset strip fins for a micro gas turbine*. 2016. DOI: 10.1016/j.ijheatmasstransfer.2016.07.071.
- [74] Airbus SE. *Airbus Aircraft 2018 Average List Prices*. 2018.
- [75] K. Willcox. *Aircraft Systems Engineering Costs Analysis: Aerospace Computational Design Laboratory, Massachusetts Institute of Technology*. 2004.
- [76] J. P. Hampstead. *Has Tesla hit a wall on battery cost improvements?* 2018. URL: <https://www.freightwaves.com/news/2018/2/28/has-tesla-hit-a-wall-on-battery-cost-improvements> (visited on 06/26/2018).
- [77] RWTH Aachen. *CeRAS-Central Reference Aircraft Data System*. 2018. URL: <http://ceras.ilr.rwth-aachen.de/> (visited on 06/03/2018).
- [78] Johanning A. and Scholz D. *Evaluation of Worldwide Noise and Pollutant Emission Costs for Integration into Direct Operating Cost Methods*. 2012.
- [79] IATA. *IATA - Jet Fuel Price Monitor*. 2018. URL: <http://www.iata.org/publications/economics/fuel-monitor/Pages/index.aspx> (visited on 06/26/2018).

A Appendix

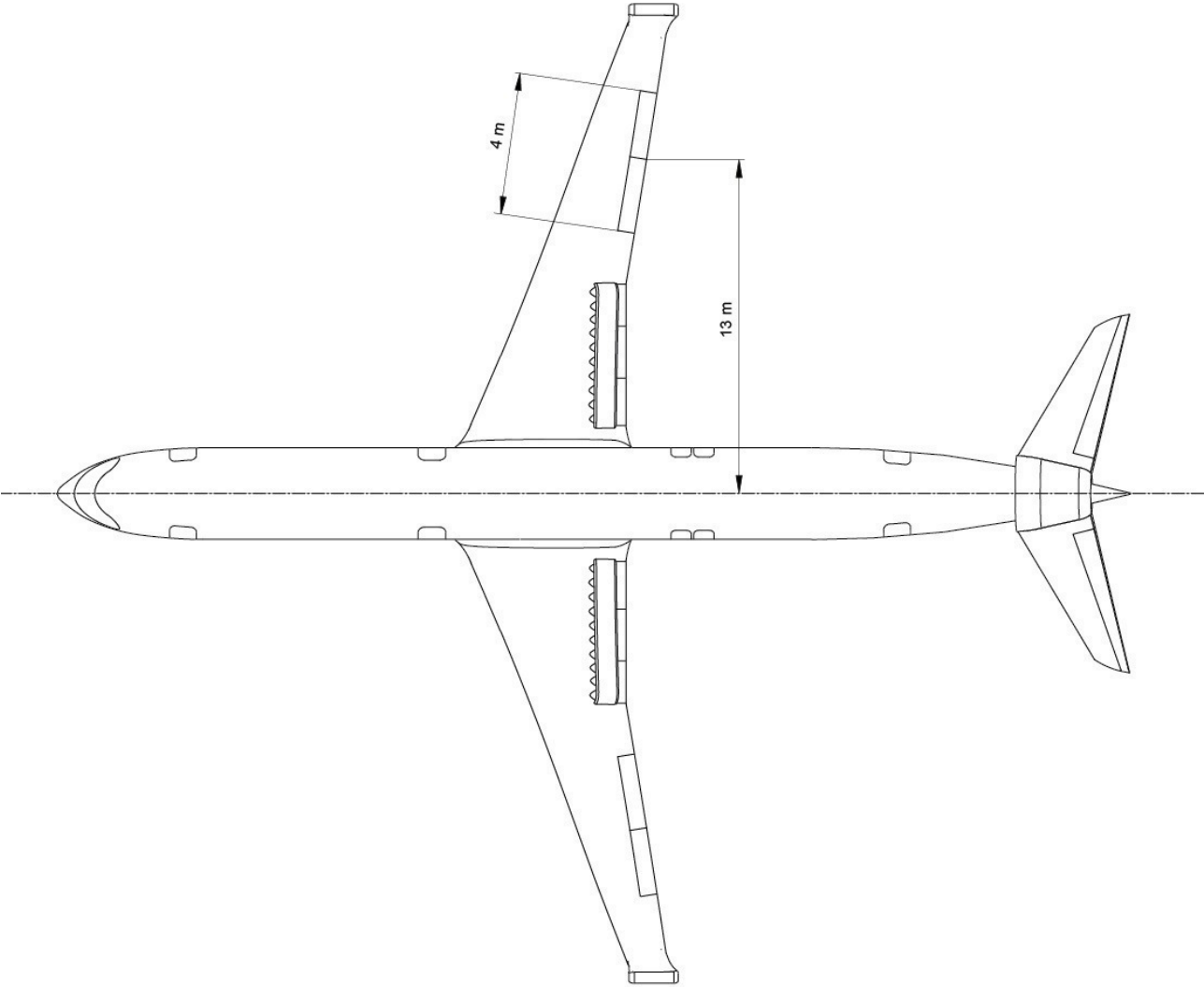

Figure 22: 3-sides view above

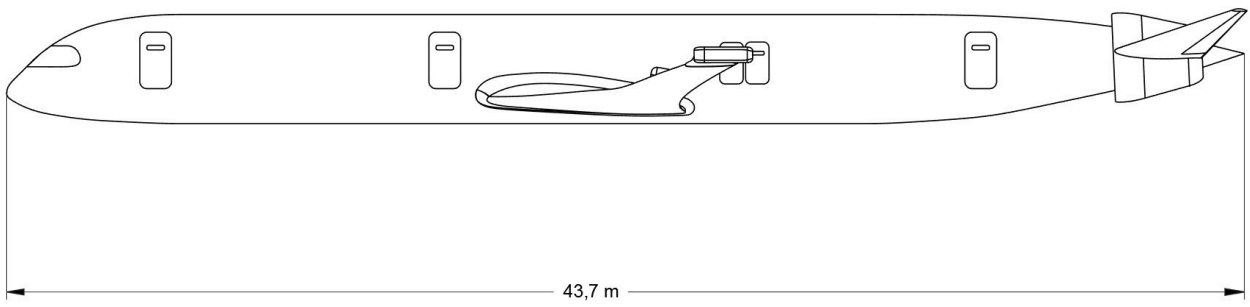

Figure 23: 3-sides view left

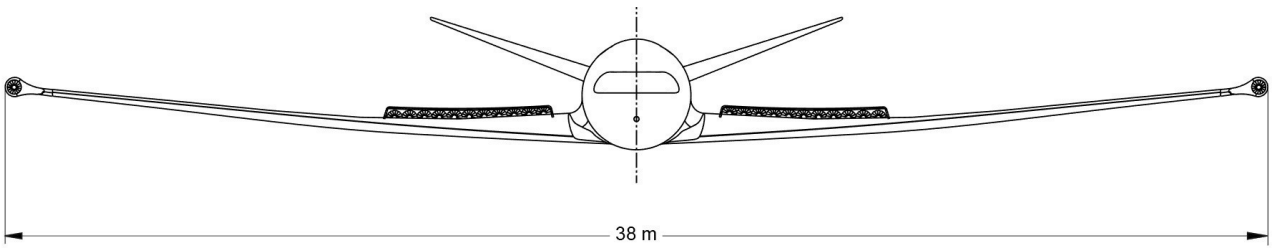

Figure 24: 3-sides view front